















Better. By Design.

# TIME DELAY RELAYS



CATALOG OF PRODUCTS

# PRODUCT SUMMARY

Product Series		Refer to:	Time Delay Setting & Ranges	Functions	Control Voltages	Output	Mounting
	<b>THR-1 Series Relay Output</b>	<b>Pages 3-9</b>	Analog-Set 0.1 SEC - 100 HR	Single-Function	12VDC, 24VAC/DC, 120VAC/DC, 240VAC	10A SPDT Relay	2" x 2" Encapsulated Panel Mounted with One Screw
	<b>THR-3 Relay Output</b>	<b>Pages 10-11</b>	Analog-Set 0.1 SEC - 100 MIN	Multi-Function (4)	24-240VAC, 12-125VDC	10A SPDT Relay	
	<b>THS-1 Series Solid State Output</b>	<b>Pages 12-15</b>	Analog-Set 0.01 SEC - 100 HR	Single-Function	24-240VAC, 12-48VDC	1A SPNO Solid State	
	<b>THL-1 Series Solid State Inline (Series) Output</b>	<b>Pages 16-17</b>	Analog-Set 0.01 SEC - 100 HR	Single-Function	24-240VAC & 12-48VDC	1A SPNO Solid State	
	<b>THL-8 Series Solid State Inline (Series) Output</b>	<b>Pages 18-19</b>	Digital-Set 0.1 SEC - 10,230 SEC	Single-Function	24-240VAC & 12-48VDC	1A SPNO Solid State	
	<b>TR-5 Series Standard</b>	<b>Pages 20-25</b>	Analog-Set 0.05 SEC - 2 HR	Single-Function	12VDC, 24VAC/DC, 120VAC/DC, 240VAC	10A DPDT 10A SPDT Relay	Plug-in Utilizing Industry-Standard 8 & 11 Pin Sockets
	<b>TR-6 Series Time Ranger Programmable</b>	<b>Pages 26-33</b>	Analog-Set Multi-Range 0.05 SEC - 100 HR	Multi-Function	24-240VAC & 12-125VDC	10A DPDT Relay	
	<b>TD-8 Series Time Ranger Digital-Set Programmable</b>	<b>Pages 34-36</b>	Digital-Set Multi-Range 0.1 SEC - 1,023 HR	Multi-Function (16) & Single-Function	12VAC/DC, 24VAC/DC, 120VAC/DC, 240VAC	10A DPDT 10A SPDT Relay	
	<b>TD-7 Series Time Ranger Digital-Set Programmable</b>	<b>Pages 37-39</b>	Digital-Set Multi-Range 0.05 SEC - 999 HR	Multi-Function (10) & Single-Function	12VAC/DC, 24VAC/DC, 120VAC/DC, 240VAC	10A DPDT 10A SPDT Relay	
	<b>TAD Series Digital-Set 1/16 DIN</b>	<b>Pages 40-41</b>	Digital-Set Multi-Range 0.01 SEC - 9,990 HR	Multi-Function (10)	24-240VAC & 24-240VDC	5A SPDT Relay	1/16 DIN (48mm <sup>2</sup> )
	<b>TAA Series Analog-Set 1/16 DIN</b>	<b>Pages 42-43</b>	Analog-Set Multi-Range 0.05 SEC - 100 HR	Multi-Function (6)-2 Versions	100-240VAC & 24-240VDC	5A DPDT & SPDT Timed & SPDT Instantaneous Relay	
	<b>TE-881 Series Programmable</b>	<b>Pages 44-45</b>	Analog-Set 0.1 SEC - 10 DAYS	Multi-Function (10)	12-240V AC/DC	15A SPDT & DPDT Relay	17.5mm
	<b>TE-6 Series Programmable</b>	<b>Pages 46-47</b>	Analog-Set 0.1 SEC - 10 0 HR	Single Function	12-240V AC/DC	10A SPDT Relay	17.5mm

# ON DELAY, INTERVAL, FLASHER, CYCLE & DELAYED INTERVAL

## RELAY OUTPUT | THR-1 SERIES

Isolated Relay Common

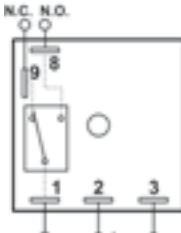
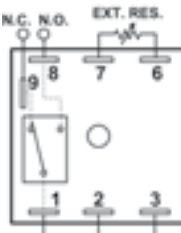
FUNCTION ■	CONTROL VOLTAGE	CATALOG NUMBER **	WIRING
<b>ON DELAY</b> A	120V AC/DC 12V DC 24V AC/DC 240V AC	THR-10262-** THR-10266-** THR-10268-** THR-10261-**	<b>Onboard Adjustable or Fixed Time Delay</b> 
<b>INTERVAL ON</b> B	120V AC/DC 12V DC 24V AC/DC 240V AC	THR-10562-** THR-10566-** THR-10568-** THR-10561-**	
<b>FLASHER</b> (OFF Time 1st) E	120V AC/DC 12V DC 24V AC/DC 240V AC	THR-10862-** THR-10866-** THR-10868-** THR-10861-**	
<b>FLASHER</b> (ON Time 1st) F	120V AC/DC 12V DC 24V AC/DC 240V AC	THR-10962-** THR-10966-** THR-10968-** THR-10961-**	<b>Remote Time Delay</b> 
<b>REPEAT CYCLE *</b> (OFF Time 1st) L	120V AC/DC 12V DC 24V AC/DC 240V AC	THR-13162-** THR-13166-** THR-13168-** THR-13161-**	
<b>REPEAT CYCLE *</b> (ON Time 1st) M	120V AC/DC 12V DC 24V AC/DC 240V AC	THR-15162-** THR-15166-** THR-15168-** THR-15161-**	
<b>DELAYED INTERVAL *</b> N	120V AC/DC 12V DC 24V AC/DC 240V AC	THR-16162-** THR-16166-** THR-16168-** THR-16161-**	



- ◆ Cost effective design & compact 2" x 2" enclosure are ideal for volume OEM applications
- ◆ Microprocessor-based design for greater performance & maximum flexibility
- ◆ Encapsulated for protection against harsh environments
- ◆ 10A SPDT relay output contacts can handle most pilot duty & fractional HP loads
- ◆ Onboard & remote adjustable or fixed time delays from 0.05 seconds to 100 hours



- See "Definitions of Timing Functions".
- \* ON & OFF Time Ranges for these functions are the same. See [www.macromatic.com/onoff](http://www.macromatic.com/onoff) for information on how to order a unit with different ON & OFF time ranges.
- \*\* Complete Product Number using two-digit Code from Table below.

## TIME DELAYS

THR-1 Series Products have three time delay options:

- **Onboard Adjustable Time Delay**--complete Product Number by adding two-digit Code from Table at right, i.e., THR-10262-30 is an On Delay with a time delay range of 0.1-10 seconds. \* See [www.macromatic.com/onoff](http://www.macromatic.com/onoff) for information on how to order these functions with different ON & OFF time ranges.
- **Onboard Fixed Time Delay**--replace two-digit Code with suffix "F" followed by delay [0.1 ... 100] followed by (S) seconds, (M) minutes or (H) hours, i.e., THR-10262-F5S is an On Delay with a time delay fixed at 5 seconds.
- **Remote Time Delay**--THR-1 Series products can be built with two terminals for remote adjustable or fixed time delays.

** TIMING RANGE TABLE	
Time Delay Range	Code
0.05 - 5 Sec.	04
0.1 - 10 Sec.	30
1 - 100 Sec.	31
10 - 1,000 Sec.	36
0.1 - 10 Min.	32
1 - 100 Min.	33
10 - 1,000 Min.	37
1 - 100 Hr.	35



Better. By Design.

**800.238.7474**

[WWW.MACROMATIC.COM](http://WWW.MACROMATIC.COM)

[SALES@MACROMATIC.COM](mailto:SALES@MACROMATIC.COM)

Build your Time Delay Relays with the [Online Product Builder](#)

# ON DELAY, INTERVAL, FLASHER, CYCLE & DELAYED INTERVAL

## RELAY OUTPUT | THR-1 SERIES

TIME DELAY RELAYS | ENCAPSULATED



- ◆ Cost effective design & compact 2" x 2" enclosure are ideal for volume OEM applications
- ◆ Microprocessor-based design for greater performance & maximum flexibility
- ◆ Encapsulated for protection against harsh environments
- ◆ 10A SPDT relay output contacts can handle most pilot duty & fractional HP loads
- ◆ Relay Common internally connected to Pin 2-makes wiring easier
- ◆ Onboard & remote adjustable or fixed time delays from 0.05 seconds to 100 hours



Better. By Design.

**800.238.7474**  
**WWW.MACROMATIC.COM**  
**SALES@MACROMATIC.COM**

Relay Common Internally Connected to Pin 2

FUNCTION ■	CONTROL VOLTAGE	CATALOG NUMBER **	WIRING
<b>ON DELAY</b> <b>A</b>	120V AC/DC 12V DC 24V AC/DC 240V AC	THR-10262-**J THR-10266-**J THR-10268-**J THR-10261-**J	<p><b>Onboard Adjustable or Fixed Time Delay</b></p> <p><b>DIAGRAM 301</b></p> <p><b>Remote Time Delay</b></p> <p><b>DIAGRAM 303</b></p>
<b>INTERVAL ON</b> <b>B</b>	120V AC/DC 12V DC 24V AC/DC 240V AC	THR-10562-**J THR-10566-**J THR-10568-**J THR-10561-**J	
<b>FLASHER</b> (OFF Time 1st) <b>E</b>	120V AC/DC 12V DC 24V AC/DC 240V AC	THR-10862-**J THR-10866-**J THR-10868-**J THR-10861-**J	
<b>FLASHER</b> (ON Time 1st) <b>F</b>	120V AC/DC 12V DC 24V AC/DC 240V AC	THR-10962-**J THR-10966-**J THR-10968-**J THR-10961-**J	
<b>REPEAT CYCLE</b> * (OFF Time 1st) <b>L</b>	120V AC/DC 12V DC 24V AC/DC 240V AC	THR-13162-**J THR-13166-**J THR-13168-**J THR-13161-**J	
<b>REPEAT CYCLE</b> * (ON Time 1st) <b>M</b>	120V AC/DC 12V DC 24V AC/DC 240V AC	THR-15162-**J THR-15166-**J THR-15168-**J THR-15161-**J	
<b>DELAYED INTERVAL</b> * <b>N</b>	120V AC/DC 12V DC 24V AC/DC 240V AC	THR-16162-**J THR-16166-**J THR-16168-**J THR-16161-**J	

■ See "Definitions of Timing Functions".

\* ON & OFF Time Ranges for these functions are the same. See [www.macromatic.com/onoff](http://www.macromatic.com/onoff) for information on how to order a unit with different ON & OFF time ranges.

\*\* Complete Product Number using two-digit Code from Table below.

### TIME DELAYS

THR-1 Series Products have three time delay options:

- **Onboard Adjustable Time Delay**--complete Product Number by adding two-digit Code from Table at right, i.e., THR-10262-30J is an On Delay with a time delay range of 0.1-10 seconds. \* See [www.macromatic.com/onoff](http://www.macromatic.com/onoff) for information on how to order these functions with different ON & OFF time ranges.
- **Onboard Fixed Time Delay**--replace two-digit Code with suffix "F" followed by delay [0.1 ... 100] followed by (S) seconds, (M) minutes or (H) hours, i.e., THR-10262-F5SJ is an On Delay with a time delay fixed at 5 seconds.
- **Remote Adjustable Time Delay**--THR-1 Series products can be built with two terminals for remote adjustable or fixed time delays.

** TIMING RANGE TABLE	
Time Delay Range	Code
0.05 - 5 Sec.	04
0.1 - 10 Sec.	30
1 - 100 Sec.	31
10 - 1,000 Sec.	36
0.1 - 10 Min.	32
1 - 100 Min.	33
10 - 1,000 Min.	37
1 - 100 Hr.	35

Build your Time Delay Relays with the [Online Product Builder](#)

# OFF DELAY, SINGLE SHOT, WATCHDOG, SINGLE SHOT FALLING EDGE, ON DELAY/OFF DELAY & DELAYED INTERVAL

## RELAY OUTPUT | THR-1 SERIES

Isolated Control Switch & Isolated Relay Common

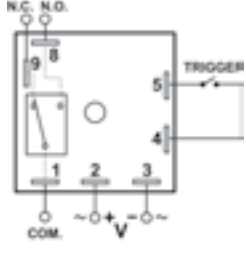
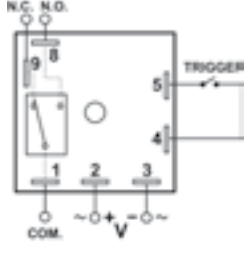
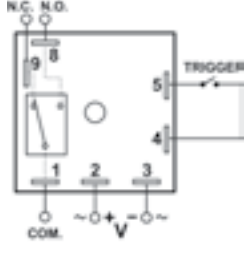
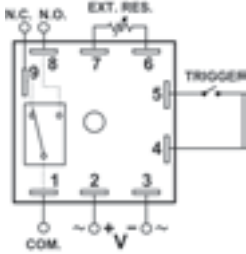
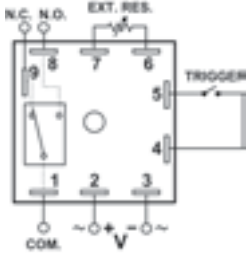
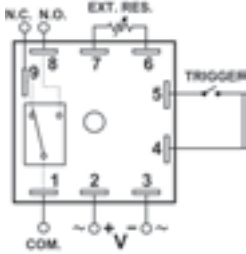
FUNCTION ■	CONTROL VOLTAGE	CATALOG NUMBER **	WIRING
<b>OFF DELAY</b> C	120V AC/DC 12V DC 24V AC/DC 240V AC	THR-11662-** THR-11666-** THR-11668-** THR-11661-**	<b>Onboard Adjustable or Fixed Time Delay</b> 
<b>SINGLE SHOT</b> D	120V AC/DC 12V DC 24V AC/DC 240V AC	THR-11562-** THR-11566-** THR-11568-** THR-11561-**	
<b>WATCHDOG</b> (Retriggerable Single Shot) J	120V AC/DC 12V DC 24V AC/DC 240V AC	THR-11362-** THR-11366-** THR-11368-** THR-11361-**	
<b>SINGLE SHOT FALLING EDGE</b> (Retriggerable) H	120V AC/DC 12V DC 24V AC/DC 240V AC	THR-12262-** THR-12266-** THR-12268-** THR-12261-**	<b>Remote Time Delay</b> 
<b>ON/OFF DELAY *</b> G	120V AC/DC 12V DC 24V AC/DC 240V AC	THR-14162-** THR-14166-** THR-14168-** THR-14161-**	
<b>DELAYED INTERVAL *</b> (Triggered) P	120V AC/DC 12V DC 24V AC/DC 240V AC	THR-16562-** THR-16566-** THR-16568-** THR-16561-**	



- ◆ Cost effective design & compact 2" x 2" enclosure are ideal for volume OEM applications
- ◆ Microprocessor-based design for greater performance & maximum flexibility
- ◆ Encapsulated for protection against harsh environments
- ◆ 10A SPDT relay output contacts can handle most pilot duty & fractional HP loads
- ◆ Onboard & remote adjustable or fixed time delays from 0.05 seconds to 100 hours



- See "Definitions of Timing Functions".
- \* ON & OFF Time Ranges for these functions are the same. See [www.macromatic.com/onoff](http://www.macromatic.com/onoff) for information on how to order a unit with different ON & OFF time ranges.
- \*\* Complete Product Number using two-digit Code from Table below.

## TIME DELAYS

THR-1 Series Products have three time delay options:

- **Onboard Adjustable Time Delay**--complete Product Number by adding two-digit Code from Table at right, i.e., THR-11662-30 is an Off Delay with a time delay range of 0.1-10 seconds.  
\* See [www.macromatic.com/onoff](http://www.macromatic.com/onoff) for information on how to order these functions with different ON & OFF time ranges.
- **Onboard Fixed Time Delay**--replace two-digit Code with suffix "F" followed by delay [0.1 ... 100] followed by (S) seconds, (M) minutes or (H) hours, i.e., THR-11662-F5S is an Off Delay with a time delay fixed at 5 seconds.
- **Remote Adjustable Time Delay**--THR-1 Series products can be built with two terminals for remote adjustable or fixed time delays.

** TIMING RANGE TABLE	
Time Delay Range	Code
0.05 - 5 Sec.	04
0.1 - 10 Sec.	30
1 - 100 Sec.	31
10 - 1,000 Sec.	36
0.1 - 10 Min.	32
1 - 100 Min.	33
10 - 1,000 Min.	37
1 - 100 Hr.	35



Better. By Design.

800.238.7474

WWW.MACROMATIC.COM

SALES@MACROMATIC.COM

Build your Time Delay Relays with the [Online Product Builder](#)

TIME DELAY RELAYS | ENCAPSULATED

# OFF DELAY, SINGLE SHOT, WATCHDOG, SINGLE SHOT FALLING EDGE, ON DELAY/OFF DELAY & DELAYED INTERVAL

## RELAY OUTPUT | THR-1 SERIES



- ◆ Cost effective design & compact 2" x 2" enclosure are ideal for volume OEM applications
- ◆ Microprocessor-based design for greater performance & maximum flexibility
- ◆ Encapsulated for protection against harsh environments
- ◆ 10A SPDT relay output contacts can handle most pilot duty & fractional HP loads
- ◆ Relay Common internally connected to Pin 2-makes wiring easier
- ◆ Onboard & remote adjustable or fixed time delays from 0.05 seconds to 100 hours



Better. By Design.

**800.238.7474**  
**WWW.MACROMATIC.COM**  
**SALES@MACROMATIC.COM**

Isolated Control Switch & Relay Common Internally Connected to Pin 2

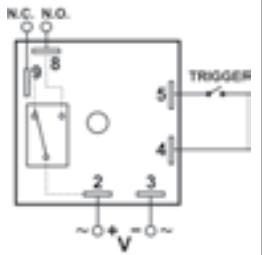
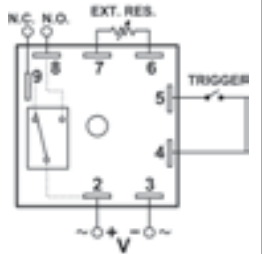
FUNCTION ■	CONTROL VOLTAGE	CATALOG NUMBER **	WIRING
<b>OFF DELAY</b> C	120V AC/DC 12V DC 24V AC/DC 240V AC	THR-11662-**J THR-11666-**J THR-11668-**J THR-11661-**J	<b>Onboard Adjustable or Fixed Time Delay</b> 
<b>SINGLE SHOT</b> D	120V AC/DC 12V DC 24V AC/DC 240V AC	THR-11562-**J THR-11566-**J THR-11568-**J THR-11561-**J	<b>Remote Time Delay</b> 
<b>WATCHDOG</b> (Retriggerable Single Shot) J	120V AC/DC 12V DC 24V AC/DC 240V AC	THR-11362-**J THR-11366-**J THR-11368-**J THR-11361-**J	
<b>SINGLE SHOT FALLING EDGE</b> (Retriggerable) H	120V AC/DC 12V DC 24V AC/DC 240V AC	THR-12262-**J THR-12266-**J THR-12268-**J THR-12261-**J	
<b>ON/OFF DELAY *</b> G	120V AC/DC 12V DC 24V AC/DC 240V AC	THR-14162-**J THR-14166-**J THR-14168-**J THR-14161-**J	
<b>DELAYED INTERVAL *</b> (Triggered) P	120V AC/DC 12V DC 24V AC/DC 240V AC	THR-16562-**J THR-16566-**J THR-16568-**J THR-16561-**J	

■ See "Definitions of Timing Functions".

\* ON & OFF Time Ranges for these functions are the same. See [www.macromatic.com/onoff](http://www.macromatic.com/onoff) for information on how to order a unit with different ON & OFF time ranges.

\*\* Complete Product Number using two-digit Code from Table below.

## TIME DELAYS

THR-1 Series Products have three time delay options:

- **Onboard Adjustable Time Delay**--complete Product Number by adding two-digit Code from Table at right, i.e., THR-11662-30J is an Off Delay with a time delay range of 0.1-10 seconds.

\* See [www.macromatic.com/onoff](http://www.macromatic.com/onoff) for information on how to order these functions with different ON & OFF time ranges.

- **Onboard Fixed Time Delay**--replace two-digit Code with suffix "F" followed by delay [0.1 ... 100] followed by (S) seconds, (M) minutes or (H) hours, i.e., THR-11662-F5SJ is an Off Delay with a time delay fixed at 5 seconds.

- **Remote Adjustable Time Delay**--THR-1 Series products can be built with two terminals for remote adjustable or fixed time delays.

** TIMING RANGE TABLE	
Time Delay Range	Code
0.05 - 5 Sec.	04
0.1 - 10 Sec.	30
1 - 100 Sec.	31
10 - 1,000 Sec.	36
0.1 - 10 Min.	32
1 - 100 Min.	33
10 - 1,000 Min.	37
1 - 100 Hr.	35

Build your Time Delay Relays with the [Online Product Builder](#)

# OFF DELAY, SINGLE SHOT, WATCHDOG, SINGLE SHOT FALLING EDGE, ON DELAY/OFF DELAY & DELAYED INTERVAL

## RELAY OUTPUT | THR-1 SERIES

Control Switch Common to Pin 2 & Isolated Relay Common

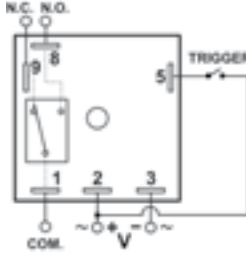
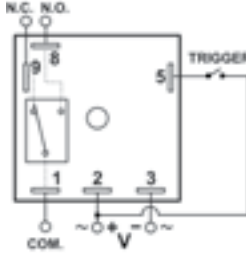
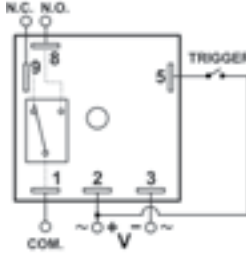
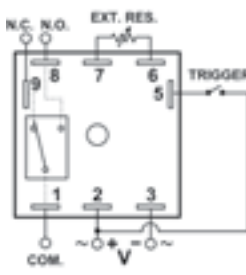
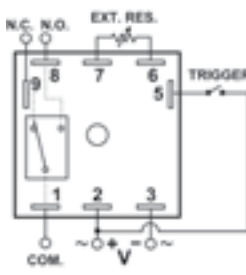
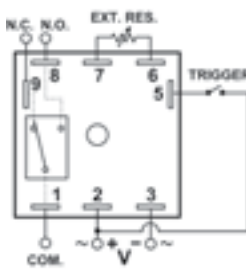
FUNCTION ■	CONTROL VOLTAGE	CATALOG NUMBER **	WIRING
<b>OFF DELAY</b> C	120V AC/DC 12V DC 24V AC/DC 240V AC	THR-11662-**T THR-11666-**T THR-11668-**T THR-11661-**T	<b>Onboard Adjustable or Fixed Time Delay</b> 
<b>SINGLE SHOT</b> D	120V AC/DC 12V DC 24V AC/DC 240V AC	THR-11562-**T THR-11566-**T THR-11568-**T THR-11561-**T	
<b>WATCHDOG</b> (Retriggerable Single Shot) J	120V AC/DC 12V DC 24V AC/DC 240V AC	THR-11362-**T THR-11366-**T THR-11368-**T THR-11361-**T	
<b>SINGLE SHOT FALLING EDGE</b> (Retriggerable) H	120V AC/DC 12V DC 24V AC/DC 240V AC	THR-12262-**T THR-12266-**T THR-12268-**T THR-12261-**T	
<b>ON/OFF DELAY *</b> G	120V AC/DC 12V DC 24V AC/DC 240V AC	THR-14162-**T THR-14166-**T THR-14168-**T THR-14161-**T	
<b>DELAYED INTERVAL *</b> (Triggered) P	120V AC/DC 12V DC 24V AC/DC 240V AC	THR-16562-**T THR-16566-**T THR-16568-**T THR-16561-**T	

■ See "Definitions of Timing Functions".

\* ON & OFF Time Ranges for these functions are the same. See [www.macromatic.com/onoff](http://www.macromatic.com/onoff) for information on how to order a unit with different ON & OFF time ranges.

\*\* Complete Product Number using two-digit Code from Table below.



- ◆ Cost effective design & compact 2" x 2" enclosure are ideal for volume OEM applications
- ◆ Microprocessor-based design for greater performance & maximum flexibility
- ◆ Encapsulated for protection against harsh environments
- ◆ 10A SPDT relay output contacts can handle most pilot duty & fractional HP loads
- ◆ Onboard & remote adjustable or fixed time delays from 0.05 seconds to 100 hours



## TIME DELAYS

THR-1 Series Products have three time delay options:

- **Onboard Adjustable Time Delay**--complete Product Number by adding two-digit Code from Table at right, i.e., THR-11662-30T is an Off Delay with a time delay range of 0.1-10 seconds. \* See [www.macromatic.com/onoff](http://www.macromatic.com/onoff) for information on how to order these functions with different ON & OFF time ranges.
- **Onboard Fixed Time Delay**--replace two-digit Code with suffix "F" followed by delay [0.1 ... 100] followed by (S) seconds, (M) minutes or (H) hours, i.e., THR-11662-F5ST is an Off Delay with a time delay fixed at 5 seconds.
- **Remote Adjustable Time Delay**--THR-1 Series products can be built with two terminals for remote adjustable or fixed time delays.

\*\* TIMING RANGE TABLE

Time Delay Range	Code
0.05 - 5 Sec.	04
0.1 - 10 Sec.	30
1 - 100 Sec.	31
10 - 1,000 Sec.	36
0.1 - 10 Min.	32
1 - 100 Min.	33
10 - 1,000 Min.	37
1 - 100 Hr.	35



Better. By Design.

800.238.7474

WWW.MACROMATIC.COM

SALES@MACROMATIC.COM

Build your Time Delay Relays with the [Online Product Builder](#)

TIME DELAY RELAYS | ENCAPSULATED

# OFF DELAY, SINGLE SHOT, WATCHDOG, SINGLE SHOT FALLING EDGE, ON DELAY/OFF DELAY & DELAYED INTERVAL

## RELAY OUTPUT | THR-1 SERIES



- ◆ Cost effective design & compact 2" x 2" enclosure are ideal for volume OEM applications
- ◆ Microprocessor-based design for greater performance & maximum flexibility
- ◆ Encapsulated for protection against harsh environments
- ◆ 10A SPDT relay output contacts can handle most pilot duty & fractional HP loads
- ◆ Relay Common internally connected to Pin 2-makes wiring easier
- ◆ Onboard & remote adjustable or fixed time delays from 0.05 seconds to 100 hours



Better. By Design.

**800.238.7474**

**WWW.MACROMATIC.COM**

**SALES@MACROMATIC.COM**

Control Switch Common to Pin 2 &  
Relay Common Internally Connected to Pin 2

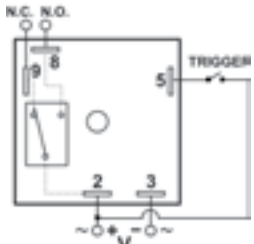
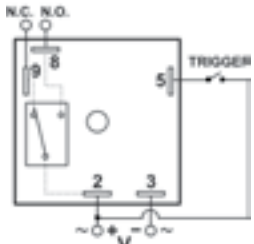
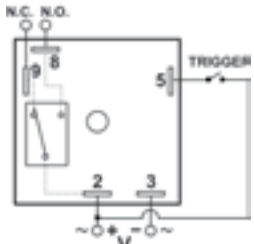
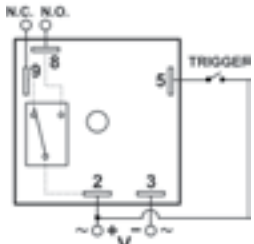
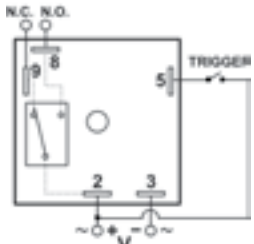
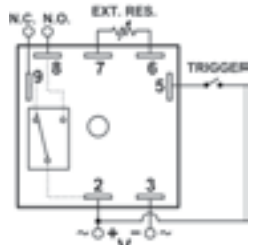
FUNCTION ■	CONTROL VOLTAGE	CATALOG NUMBER **	WIRING
<b>OFF DELAY</b> C	120V AC/DC 12V DC 24V AC/DC 240V AC	THR-11662-**JT THR-11666-**JT THR-11668-**JT THR-11661-**JT	<b>Onboard Adjustable or Fixed Time Delay</b> 
<b>SINGLE SHOT</b> D	120V AC/DC 12V DC 24V AC/DC 240V AC	THR-11562-**JT THR-11566-**JT THR-11568-**JT THR-11561-**JT	
<b>WATCHDOG</b> (Retriggerable Single Shot) J	120V AC/DC 12V DC 24V AC/DC 240V AC	THR-11362-**JT THR-11366-**JT THR-11368-**JT THR-11361-**JT	
<b>SINGLE SHOT FALLING EDGE</b> (Retriggerable) H	120V AC/DC 12V DC 24V AC/DC 240V AC	THR-12262-**JT THR-12266-**JT THR-12268-**JT THR-12261-**JT	
<b>ON/OFF DELAY *</b> G	120V AC/DC 12V DC 24V AC/DC 240V AC	THR-14162-**JT THR-14166-**JT THR-14168-**JT THR-14161-**JT	
<b>DELAYED INTERVAL *</b> (Triggered) P	120V AC/DC 12V DC 24V AC/DC 240V AC	THR-16562-**JT THR-16566-**JT THR-16568-**JT THR-16561-**JT	

■ See "Definitions of Timing Functions".

\* ON & OFF Time Ranges for these functions are the same. See [www.macromatic.com/onoff](http://www.macromatic.com/onoff) for information on how to order a unit with different ON & OFF time ranges.

\*\* Complete Product Number using two-digit Code from Table below.

## TIME DELAYS

THR-1 Series Products have three time delay options:

- **Onboard Adjustable Time Delay**--complete Product Number by adding two-digit Code from Table at right, i.e., THR-11662-30JT is an Off Delay with a time delay range of 0.1-10 seconds.  
\* See [www.macromatic.com/onoff](http://www.macromatic.com/onoff) for information on how to order these functions with different ON & OFF time ranges.
- **Onboard Fixed Time Delay**--replace two-digit Code with suffix "F" followed by delay [0.1 ... 100] followed by (S) seconds, (M) minutes or (H) hours, i.e., THR-11662-F5SJT is an Off Delay with a time delay fixed at 5 seconds.
- **Remote Adjustable Time Delay**--THR-1 Series products can be built with two terminals for remote adjustable or fixed time delays.

\*\* TIMING RANGE TABLE

Time Delay Range	Code
0.05 - 5 Sec.	04
0.1 - 10 Sec.	30
1 - 100 Sec.	31
10 - 1,000 Sec.	36
0.1 - 10 Min.	32
1 - 100 Min.	33
10 - 1,000 Min.	37
1 - 100 Hr.	35

Build your Time Delay Relays with the [Online Product Builder](#)



# THR-1 SERIES

## RELAY OUTPUT

### APPLICATION DATA

#### Voltage Tolerance:

AC Operation: +10/-15% of nominal at 50/60 Hz  
 DC Operation: +10/-15% of nominal

**Load (Burden):** Maximum of 2 VA for all voltages

#### Setting Accuracy:

Maximum Setting (Adjustable): +5%, -0%  
 Minimum Setting (Adjustable): +0%, -50%  
 Fixed Time Delay: ±2% or 50ms, whichever is greater

**Repeat Accuracy** (constant voltage and temperature):  
 ±0.1% or ± 0.04 seconds, whichever is greater

#### Reset Time:

Triggered with Control voltage : 100ms  
 Triggered with Control Switch: 40ms

**Start-up Time** (Time from when power is applied until unit is timing): 0.05 Seconds

**Maintain Function Time** (Time unit continues to operate after power is removed): 0.01 Seconds

#### Units Triggered by a Control Switch:

Minimum required trigger switch closure time is 50ms.

#### Temperature:

Operate: -28° to 65°C (-18° to 149°F)  
 Storage: -45° to 85°C (-49° to 185°F)

#### Output Contacts:

10A @ 240VAC / 7A @ 28VDC SPDT, 1/4hp @ 120VAC (N.O.)

#### Life:

Mechanical: 10,000,000 operations  
 Full Load: 100,000 operations

#### Compatibility:

Using a solid state switch to initiate the time sequence is acceptable. See [www.macromatic.com/leakage](http://www.macromatic.com/leakage) or contact Macromatic for information regarding leakage current limits and other solid state design considerations.

#### Mounting:

Surface with one #8 or #10 screw and a maximum tightening torque of 15 in-lbs.

#### Termination:

0.25" male quick-connect terminals

#### Approvals:



### DIMENSIONS

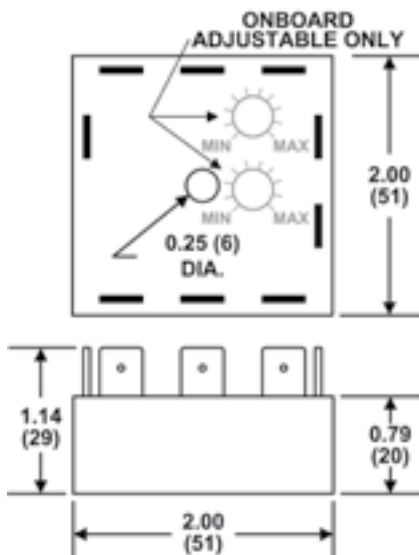

All Dimensions in Inches (Millimeters)

### REMOTE TIME DELAY

Most THR-1 Series products can be built with two terminals for remote adjustable or fixed time delays. To order a product with a remote time delay, complete the Product Number by adding the two-digit Code from the Table shown on the appropriate product selection page followed by the suffix "R1", i.e., THR-10262-30R1. Contact Macromatic for information on limitations of remote time delays on functions with ON & OFF timing ranges.

#### Adjustable Time Delay

A 100K ohm potentiometer is required to obtain the maximum time delay for all standard ranges. To use other values of remote potentiometers, contact Macromatic.

#### Fixed Time Delay

A fixed time delay can be set by connecting a resistor across the two terminals. To determine the resistor value required, use the following equation:

$$R = \frac{T}{T_{\max}} \times 100,000$$

R = Resistance value required to obtain T  
 T = Desired time delay  
 T<sub>max</sub> = Maximum time delay of range

**Example:** Using time range 0.1-10 seconds, what resistor value is required for a fixed time delay of 5 seconds:

$$R = \frac{5}{10} \times 100,000 = 50,000 \text{ ohms (50K ohms)}$$

# MULTI-FUNCTION | PROGRAMMABLE MULTI-TIME RANGE | MULTI-VOLTAGE RELAY OUTPUT | THR-3 SERIES



- ◆ Three Catalog Numbers Offer All These Features:
  - ▶ Multi-Function: 4 common time delay functions in each one
  - ▶ Universal Voltage: 24-240VAC & 12-125VDC
  - ▶ Time Ranges: 0.1 Sec to 100 Minutes (1,000 Minutes on Dual Time product)
  - ▶ Onboard & remote adjust of time delay (remote adjust not offered on THR-3856U)
  - ▶ THR-3856U allows different ON & OFF times
- ◆ Cost effective design & compact 2" x 2" enclosure
- ◆ Encapsulated for protection against harsh environments
- ◆ 10A SPDT relay output contacts can handle most pilot duty & fractional HP loads



Better. By Design.

**800.238.7474**  
**WWW.MACROMATIC.COM**  
**SALES@MACROMATIC.COM**

The THR-3 Series products are designed to replace thousands of products from Macromatic and many other manufacturers with just three Catalog Numbers. Each comes with four functions and four timing ranges covering 0.1 second to 100 minutes (1,000 minutes on THR-3856U dual time unit). On the same unit, choose between onboard adjustable, onboard fixed and remote adjustable time delay setting (remote time delay not available on THR-3856U). All set up is done with DIP switches for ease of use. A universal control voltage of 24-240V AC and 12-125V DC adds to the ultimate flexibility of these products. All products are encapsulated for protection against harsh elements. A 10A SPDT relay output rating can handle most pilot duty and fractional HP loads.

FUNCTIONS (4 in each Product)	CONTROL VOLTAGE	CATALOG NUMBER	WIRING
<ul style="list-style-type: none"> <li>● ON DELAY</li> <li>● OFF DELAY</li> <li>● INTERVAL</li> <li>● SINGLE SHOT</li> </ul>	24-240V AC & 12-125V DC	THR-3816U	<p>Diagram 348</p>
<ul style="list-style-type: none"> <li>● FLASHER OFF</li> <li>● FLASHER ON</li> <li>● WATCHDOG</li> <li>● SINGLE SHOT FALLING EDGE</li> </ul>	24-240V AC & 12-125V DC	THR-3836U	<p>Diagram 348</p>
<ul style="list-style-type: none"> <li>● REPEAT CYCLE OFF</li> <li>● REPEAT CYCLE ON</li> <li>● DELAYED INTERVAL</li> <li>● DELAYED INTERVAL (TRIGGERED)</li> </ul>	24-240V AC & 12-125V DC	THR-3856U *	<p>Diagram 352</p>

Some functions require the use of a Trigger to initiate the unit.

See Macromatic Catalog or [www.macromatic.com/functions](http://www.macromatic.com/functions) for definitions & explanations of Timing Functions.

\* The THR-3856U has independently selectable & adjustable ON & OFF times.

## TIME DELAYS

THR-3 Series Products have three time delay options (two for THR-3856U dual-time product):

- **Onboard Adjustable Time Delay**-after selecting the desired time range, use the top-mounted potentiometer provided with the unit to adjust within that range (The THR-3856U has independently selectable & adjustable ON & OFF times).
- **Onboard Fixed Time Delay**-although these units come with an onboard potentiometer, they can be used to replace products with fixed time delays. After selecting the desired time range, set the top-mounted potentiometer at the fixed delay required (epoxy can be applied to prevent further changes if desired).
- **Remote Time Delay (THR-3816U & THR-3836U only)**-after selecting the desired time range & setting up the unit for remote time delay adjustment, connect a remote potentiometer for remote adjustability or a resistor for fixed time delay. Note that these products will only work with 100K, 1M or 2M remote potentiometers or resistors.

Build your Time Delay Relays with the [Online Product Builder](#)

# PROGRAMMABLE MULTI-FUNCTION | MULTI-TIME RANGE | MULTI-VOLTAGE RELAY OUTPUT | THR-3 SERIES

## APPLICATION DATA

### Voltage Tolerance:

AC Operation: +10/-15% of nominal at 50/60 Hz

DC Operation: +10/-15% of nominal

**Load (Burden):** Maximum of 2 VA for all voltages

### Setting Accuracy:

Maximum Setting (Adjustable): +5%, -0%

Minimum Setting (Adjustable): +0%, -50%

### Repeat Accuracy (constant voltage and temperature):

±0.1% or ± 0.04 seconds, whichever is greater

### Reset Time:

Triggered with Control voltage : 100ms

Triggered with Control Switch: 40ms

### Start-up Time (Time from when power is applied until unit is timing):

0.05 Seconds

### Maintain Function Time (Time unit continues to operate after power is removed):

0.01 Seconds

### Units Triggered by a Control Switch:

Minimum required trigger switch closure time is 50ms.

**Temperature:** Operating: -28° to 65°C (-18° to 149°F)

Storage: -40° to 85°C (-40° to 185°F)

### Output Contacts:

10A @ 240VAC / 7A @ 28VDC SPDT, ¼hp @ 120VAC (N.O.)

### Life:

Mechanical: 10,000,000 operations

Full Load: 100,000 operations

### Compatibility:

Using a solid state switch to initiate the time sequence is acceptable.

See [www.macromatic.com/leakage](http://www.macromatic.com/leakage) or contact Macromatic for information regarding leakage current limits and other solid state design considerations.

### Mounting:

Surface with one #8 or #10 screw and a maximum tightening torque of 15 in-lbs.

### Termination:

0.25" male quick-connect terminals

### Approvals:



## DIMENSIONS

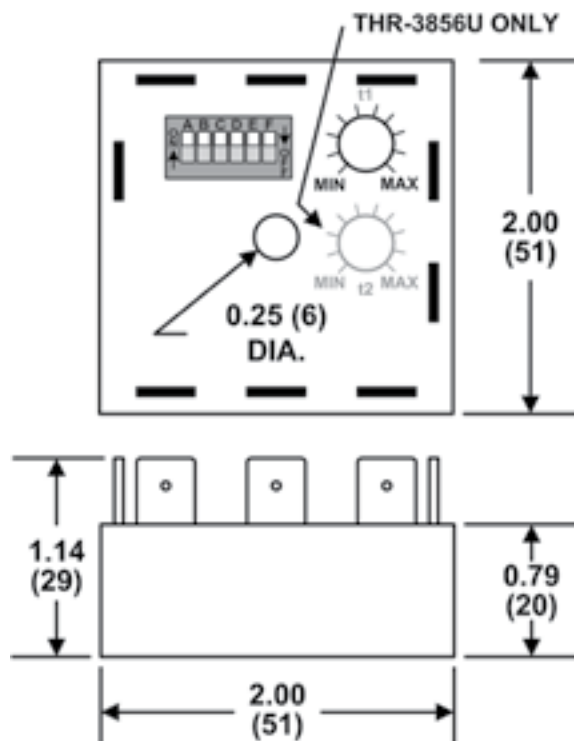

All Dimensions in Inches (Millimeters)

# ON DELAY, INTERVAL, FLASHER, CYCLE & DELAYED INTERVAL

## SOLID STATE OUTPUT | THS-1 SERIES

TIME DELAY RELAYS | ENCAPSULATED



- ◆ Cost effective design & compact 2" x 2" enclosure are ideal for volume OEM applications
- ◆ Microprocessor-based design for greater performance & maximum flexibility
- ◆ Encapsulated for protection against harsh environments
- ◆ Output rated 1A continuous/10A inrush is perfect for high duty cycle/long life applications
- ◆ Onboard & remote adjustable or fixed time delays from 0.01 seconds to 100 hours
- ◆ Built-in load suppression eliminates need for separate protection
- ◆ Pilot duty rating



Better. By Design.

**800.238.7474**

**WWW.MACROMATIC.COM**

**SALES@MACROMATIC.COM**

FUNCTION ■	CONTROL VOLTAGE	CATALOG NUMBER **	WIRING ❖
<b>ON DELAY</b> □ <b>A</b>	24-240V AC 12-125V DC	THS-1024A-** THS-1024D-**	<b>Onboard Adjustable or Fixed Time Delay</b> 
<b>INTERVAL ON</b> <b>B</b>	24-240V AC 12-125V DC	THS-1054A-** THS-1054D-**	
<b>FLASHER</b> (ON Time 1st) <b>E</b>	24-240V AC 12-125V DC	THS-1094A-** THS-1094D-**	<b>Remote Time Delay</b> 
<b>REPEAT CYCLE</b> * (OFF Time 1st) <b>L</b>	24-240V AC 12-125V DC	THS-1314A-** THS-1314D-**	
<b>REPEAT CYCLE</b> * (ON Time 1st) <b>M</b>	24-240V AC 12-125V DC	THS-1514A-** THS-1514D-**	<b>Remote Time Delay</b> 
<b>DELAYED INTERVAL</b> * <b>N</b>	24-240V AC 12-125V DC	THS-1614A-** THS-1614D-**	

- See "Definitions of Timing Functions".
- See Inline (Series-Connection) On Delay.
- ❖ Diagrams shown are for products with AC control voltage. For products with DC control voltage, the "+" terminal is 2 & the "-" terminal is 3.
- \* ON & OFF Time Ranges for these functions are the same. See [www.macromatic.com/onoff](http://www.macromatic.com/onoff) for information on how to order a unit with different ON & OFF time ranges.
- \*\* Complete Product Number using two-digit Code from Table below.

### TIME DELAYS

THS-1 Series Products have three time delay options:

- **Onboard Adjustable Time Delay**--complete Product Number by adding two-digit Code from Table at right, i.e., THS-1054A-30 is an Interval On with a time delay range of 0.1-10 seconds. \* See [www.macromatic.com/onoff](http://www.macromatic.com/onoff) for information on how to order these functions with different ON & OFF time ranges.
- **Onboard Fixed Time Delay**--replace two-digit Code with suffix "F" followed by delay [0.1 ... 100] followed by (S) seconds, (M) minutes or (H) hours, i.e., THS-1054A-F5S is an Interval On with a time delay fixed at 5 seconds.
- **Remote Time Delay**--THS-1 Series products can be built with two terminals for remote adjustable or fixed time delays.

\*\* TIMING RANGE TABLE

Time Delay Range	Code
0.01 - 1 Sec.	02
0.05 - 5 Sec.	04
0.1 - 10 Sec.	30
1 - 100 Sec.	31
10 - 1,000 Sec.	36
0.1 - 10 Min.	32
1 - 100 Min.	33
10 - 1,000 Min.	37
1 - 100 Hr.	35

Build your Time Delay Relays with the [Online Product Builder](#)

# OFF DELAY, SINGLE SHOT, WATCHDOG, SINGLE SHOT FALLING EDGE, ON DELAY/OFF DELAY & DELAYED INTERVAL

## SOLID STATE OUTPUT | THS-1 SERIES

### Isolated Control Switch

FUNCTION ■	CONTROL VOLTAGE	CATALOG NUMBER **	WIRING ❖
<b>OFF DELAY</b> C	24-240V AC 12-125V DC	THS-1164A-** THS-1164D-**	<b>Onboard Adjustable or Fixed Time Delay</b> 
<b>SINGLE SHOT</b> D	24-240V AC 12-125V DC	THS-1154A-** THS-1154D-**	
<b>WATCHDOG</b> (Retriggerable Single Shot) J	24-240V AC 12-125V DC	THS-1134A-** THS-1134D-**	<b>Remote Time Delay</b> 
<b>SINGLE SHOT FALLING EDGE</b> (Retriggerable) H	24-240V AC 12-125V DC	THS-1224A-** THS-1224D-**	
<b>ON/OFF DELAY *</b> G	24-240V AC 12-125V DC	THS-1414A-** THS-1414D-**	<b>DIAGRAM 321</b>
<b>DELAYED INTERVAL *</b> (Retriggerable) P	24-240V AC 12-125V DC	THS-1654A-** THS-1654D-**	



- ◆ Cost effective design & compact 2" x 2" enclosure are ideal for volume OEM applications
- ◆ Microprocessor-based design for greater performance & maximum flexibility
- ◆ Encapsulated for protection against harsh environments
- ◆ Output rated 1A continuous/10A inrush is perfect for high duty cycle/long life applications
- ◆ Onboard & remote adjustable or fixed time delays from 0.01 seconds to 100 hours
- ◆ Built-in load suppression eliminates need for separate protection
- ◆ Pilot duty rating



■ See "Definitions of Timing Functions".

❖ Diagrams shown are for products with AC control voltage. For products with DC control voltage, the "+" terminal is 2 & the "-" terminal is 3.

\* ON & OFF Time Ranges for these functions are the same. See [www.macromatic.com/onoff](http://www.macromatic.com/onoff) for information on how to order a unit with different ON & OFF time ranges.

\*\* Complete Product Number using two-digit Code from Table below.

## TIME DELAYS

THS-1 Series Products have three time delay options:

- **Onboard Adjustable Time Delay**--complete Product Number by adding two-digit Code from Table at right, i.e., THS-1164A-30 is an Off Delay with a time delay range of 0.1-10 seconds. \* See [www.macromatic.com/onoff](http://www.macromatic.com/onoff) for information on how to order these functions with different ON & OFF time ranges.
- **Onboard Fixed Time Delay**--replace two-digit Code with suffix "F" followed by delay [0.1 ... 100] followed by (S) seconds, (M) minutes or (H) hours, i.e., THS-1164A-F5S is an Off Delay with a time delay fixed at 5 seconds.
- **Remote Time Delay**--THS-1 Series products can be built with two terminals for remote adjustable or fixed time delays.

\*\* TIMING RANGE TABLE

Time Delay Range	Code
0.01 - 1 Sec.	02
0.05 - 5 Sec.	04
0.1 - 10 Sec.	30
1 - 100 Sec.	31
10 - 1,000 Sec.	36
0.1 - 10 Min.	32
1 - 100 Min.	33
10 - 1,000 Min.	37
1 - 100 Hr.	35



Better. By Design.

800.238.7474

WWW.MACROMATIC.COM

SALES@MACROMATIC.COM

Build your Time Delay Relays with the [Online Product Builder](#)

TIME DELAY RELAYS | ENCAPSULATED

# OFF DELAY, SINGLE SHOT, WATCHDOG, SINGLE SHOT FALLING EDGE, ON DELAY/OFF DELAY & DELAYED INTERVAL

## SOLID STATE OUTPUT | THS-1 SERIES

Control Switch Common to Pin 2



- ◆ Cost effective design & compact 2" x 2" enclosure are ideal for volume OEM applications
- ◆ Microprocessor-based design for greater performance & maximum flexibility
- ◆ Encapsulated for protection against harsh environments
- ◆ Output rated 1A continuous/10A inrush is perfect for high duty cycle/long life applications
- ◆ Onboard & remote adjustable or fixed time delays from 0.01 seconds to 100 hours
- ◆ Built-in load suppression eliminates need for separate protection
- ◆ Pilot duty rating



Better. By Design.

800.238.7474

WWW.MACROMATIC.COM

SALES@MACROMATIC.COM

FUNCTION ■	CONTROL VOLTAGE	CATALOG NUMBER **	WIRING ❖
<b>OFF DELAY</b> C	24-240V AC 12-125V DC	THS-1164A-**T THS-1164D-**T	<p><b>DIAGRAM 319</b></p> <p><b>DIAGRAM 322</b></p>
<b>SINGLE SHOT</b> D	24-240V AC 12-125V DC	THS-1154A-**T THS-1154D-**T	
<b>WATCHDOG</b> (Retriggerable Single Shot) J	24-240V AC 12-125V DC	THS-1134A-**T THS-1134D-**T	
<b>SINGLE SHOT FALLING EDGE</b> (Retriggerable) H	24-240V AC 12-125V DC	THS-1224A-**T THS-1224D-**T	
<b>ON/OFF DELAY *</b> G	24-240V AC 12-125V DC	THS-1414A-**T THS-1414D-**T	
<b>DELAYED INTERVAL *</b> (Retriggerable) P	24-240V AC 12-125V DC	THS-1654A-**T THS-1654D-**T	

■ See "Definitions of Timing Functions".

❖ Diagrams shown are for products with AC control voltage. For products with DC control voltage, the "+" terminal is 2 & the "-" terminal is 3.

\* ON & OFF Time Ranges for these functions are the same. See [www.macromatic.com/onoff](http://www.macromatic.com/onoff) for information on how to order a unit with different ON & OFF time ranges.

\*\* Complete Product Number using two-digit Code from Table below.

### TIME DELAYS

THS-1 Series Products have three time delay options:

- **Onboard Adjustable Time Delay**--complete Product Number by adding two-digit Code from Table at right, i.e., THS-1164A-30T is an Off Delay with a time delay range of 0.1-10 seconds. \* See [www.macromatic.com/onoff](http://www.macromatic.com/onoff) for information on how to order these functions with different ON & OFF time ranges.
- **Onboard Fixed Time Delay**--replace two-digit Code with suffix "F" followed by delay [0.1 ... 100] followed by (S) seconds, (M) minutes or (H) hours, i.e., THS-1164A-F5ST is an Off Delay with a time delay fixed at 5 seconds.
- **Remote Time Delay**--THS-1 Series products can be built with two terminals for remote adjustable or fixed time delays.

#### \*\* TIMING RANGE TABLE

Time Delay Range	Code
0.01 - 1 Sec.	02
0.05 - 5 Sec.	04
0.1 - 10 Sec.	30
1 - 100 Sec.	31
10 - 1,000 Sec.	36
0.1 - 10 Min.	32
1 - 100 Min.	33
10 - 1,000 Min.	37
1 - 100 Hr.	35

Build your Time Delay Relays with the [Online Product Builder](#)

# THS-1 SERIES

## SOLID STATE OUTPUT

### APPLICATION DATA

#### Voltage Tolerance:

AC Operation: +10 to -15% of nominal voltage, 50/60 Hz  
 DC Operation: +10 to -15% of nominal voltage

**Load (Burden):** Maximum of 1VA for all voltages

#### Setting Accuracy:

Maximum Setting (Adjustable): +5%, -0%  
 Minimum Setting (Adjustable): +0%, -50%  
 Fixed Time Delay: ±2% or 50ms, whichever is greater

#### Repeat Accuracy (constant voltage and temperature):

±0.1% or ± 0.04 seconds, whichever is greater

#### Reset Time:

Triggered with Control voltage : 50ms  
 Triggered with Control Switch: 40ms

#### Start-up Time:

(Time from when power is applied until unit is timing)  
 0.05 Seconds

#### Maintain Function Time:

(Time unit continues to operate after power is removed)  
 0.01 Seconds

#### Units Triggered by a Control Switch:

Minimum required trigger switch closure time is 50ms.

**Temperature:** Operating: -28° to 65°C (-18° to 149°F)

Storage: -40° to 85°C (-40° to 185°F)

#### Output Contacts:

Normally Open Solid State 1A Continuous, 10A Inrush @ 65° C, Pilot Duty

#### Life:

No predictable failure if used within operating parameters.

**Leakage Current (OFF-State):** < 5ma @ 240V AC

**Minimum Load Current:** 20ma

**Effective Voltage Drop (ON-State):** Maximum 1.6V @ 1A for all voltages

#### Compatibility:

Using a solid state switch to initiate the time sequence is acceptable. See [www.macromatic.com/leakage](http://www.macromatic.com/leakage) or contact Macromatic for information regarding leakage current limits and other solid state design considerations.

#### Mounting:

Surface with one #8 or #10 screw and a maximum tightening torque of 15 in-lbs.

#### Termination:

0.25" male quick-connect terminals

#### Approvals:



### DIMENSIONS

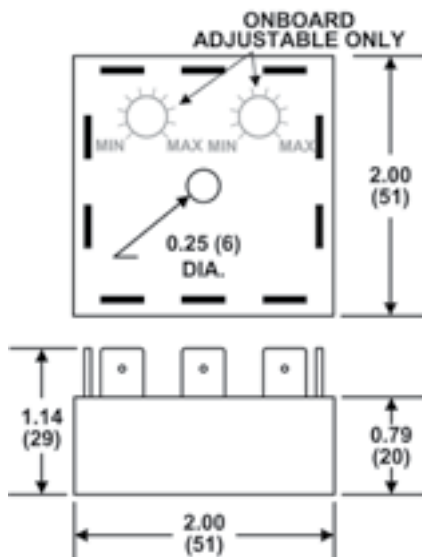

All Dimensions in Inches (Millimeters)

### REMOTE TIME DELAY

THS-1 Series products can be built with two terminals for remote adjustable or fixed time delays. To order a product with a remote time delay, complete the Product Number by adding the two-digit Code from the Table shown on the appropriate product selection page followed by the suffix "R1", i.e., THS-10242-30R1.

#### Adjustable Time Delay

A 100K ohm potentiometer is required to obtain the maximum time delay for all standard ranges. To use other values of remote potentiometers, contact Macromatic.

#### Fixed Time Delay

A fixed time delay can be set by connecting a resistor across the two terminals. To determine the resistor value required, use the following equation:

$$R = \frac{T}{T_{\max}} \times 100,000$$

R = Resistance value required to obtain T  
 T = Desired time delay  
 T<sub>max</sub> = Maximum time delay of range

**Example:** Using time range 0.1-10 seconds, what resistor value is required for a fixed time delay of 5 seconds:

$$R = \frac{5}{10} \times 100,000 = 50,000 \text{ ohms (50K ohms)}$$

# ON DELAY | INLINE (SERIES CONNECTION)

SOLID STATE OUTPUT | ANALOG-SET | THL-1 SERIES



- ◆ Universal control voltage : 24-240V AC & 12-48V DC
- ◆ Onboard & remote adjustable or fixed time delays from 0.01 seconds to 100 hours
- ◆ Two-terminal series-connection with the load
- ◆ Cost effective design & compact 2" x 2" enclosure are ideal for volume OEM applications
- ◆ Microprocessor-based design for greater performance & maximum flexibility
- ◆ Encapsulated for protection against harsh environments
- ◆ Output rated 1A continuous/10A inrush pilot duty is perfect for high duty cycle/long life applications



Better. By Design.

800.238.7474

WWW.MACROMATIC.COM

SALES@MACROMATIC.COM

FUNCTION ■	CONTROL VOLTAGE	CATALOG NUMBER **	WIRING
ON DELAY <b>A</b>	24-240V AC & 12-48V DC	THL-1024U-**	<p>Onboard Adjustable or Fixed Time Delay</p> <p>DIAGRAM 329</p> <p>Remote Time Delay</p> <p>DIAGRAM 330</p>

■ See "Definitions of Timing Functions".

\*\* Complete Product Number using two-digit Code from Table below.

## TIME DELAYS

THL-1 Series Products have three time delay options:

- **Onboard Adjustable Time Delay**--complete Product Number by adding two-digit Code from Table at right, i.e., THL-1024U-30 is an On Delay with a time delay range of 0.1-10 seconds.
- **Onboard Fixed Time Delay**--replace two-digit Code with suffix "F" followed by delay [0.1 ... 100] followed by (S) seconds, (M) minutes or (H) hours, i.e., THL-1024U-F5S is an On Delay with a time delay fixed at 5 seconds.
- **Remote Time Delay**--THL-1 Series products can be built with two terminals for remote adjustable or fixed time delays.

** TIMING RANGE TABLE	
Time Delay Range	Code
0.01 - 1 Sec.	02
0.05 - 5 Sec.	04
0.1 - 10 Sec.	30
1 - 100 Sec.	31
10 - 1,000 Sec.	36
0.1 - 10 Min.	32
1 - 100 Min.	33
10 - 1,000 Min.	37
1 - 100 Hr.	35

Build your Time Delay Relays with the [Online Product Builder](#)



# ON DELAY | INLINE (SERIES CONNECTION)

## SOLID STATE OUTPUT | ANALOG-SET | THL-1 SERIES

### APPLICATION DATA

#### Voltage Tolerance:

AC Operation: +10 to -15% of nominal voltage, 50/60 Hz  
DC Operation: +10 to -15% of nominal voltage

**Load (Burden):** Maximum of 1 VA for all voltages

#### Setting Accuracy:

Maximum Setting (Adjustable): +5%, -0%  
Minimum Setting (Adjustable): +0%, -50%  
Fixed Time Delay: ±2% or 50ms, whichever is greater

**Repeat Accuracy** (constant voltage and temperature):  
±0.1% or ± 0.01 seconds, whichever is greater

**Reset Time:** 50ms

#### Start-up Time:

(Time from when power is applied until unit is timing)

0.02 Seconds

#### Maintain Function Time:

(Time unit continues to operate after power is removed)

0.01 Seconds

**Temperature:** Operating: -28° to 65°C (-18° to 149°F)  
Storage: -40° to 85°C (-40° to 185°F)

#### Output Contacts:

Normally Open Solid State 1A Continuous, 10A Inrush @ 65° C, Pilot Duty

#### Life:

No predictable failure if used within operating parameters.

**Leakage Current (OFF-State):** < 5ma @ 240V AC

**Minimum Load Current:** 20ma

**Effective Voltage Drop (ON-State):** Maximum 3V @ 1A for all voltages

#### Compatibility:

Using a solid state switch to initiate the time sequence is acceptable. See [www.macromatic.com/leakage](http://www.macromatic.com/leakage) or contact Macromatic for information regarding leakage current limits and other solid state design considerations.

#### Mounting:

Surface with one #8 or #10 screw and a maximum tightening torque of 15 in-lbs.

#### Termination:

0.25" male quick-connect terminals

#### Approvals:

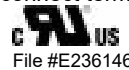

### DIMENSIONS

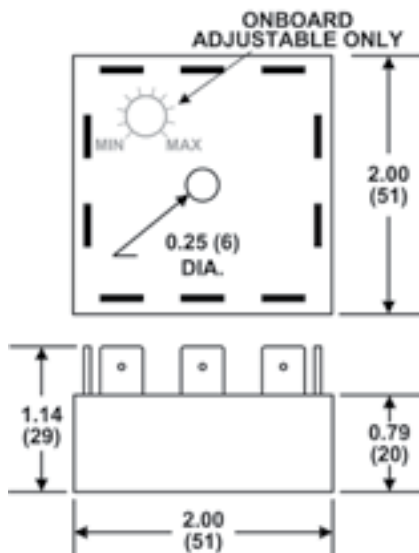

All Dimensions in Inches (Millimeters)

### REMOTE TIME DELAY

THL-1 Series products can be built with two terminals for remote adjustable or fixed time delays. To order a product with a remote time delay, complete the Product Number by adding the two-digit Code from the Table shown on the appropriate product selection page followed by the suffix "R1", i.e., THL-1024U-30R1.

#### Adjustable Time Delay

A 100K ohm potentiometer is required to obtain the maximum time delay for all standard ranges. To use other values of remote potentiometers, contact Macromatic.

#### Fixed Time Delay

A fixed time delay can be set by connecting a resistor across the two terminals. To determine the resistor value required, use the following equation:

$$R = \frac{T}{T_{\max}} \times 100,000$$

R = Resistance value required to obtain T  
T = Desired time delay  
T<sub>max</sub> = Maximum time delay of range

**Example:** Using time range 0.1-10 seconds, what resistor value is required for a fixed time delay of 5 seconds:

$$R = \frac{5}{10} \times 100,000 = 50,000 \text{ ohms (50K ohms)}$$

# ON DELAY | INLINE (SERIES CONNECTION)

SOLID STATE OUTPUT | DIP-SWITCH DIGITAL-SET | THL-8 SERIES



- ◆ Universal control voltage : 24-240V AC & 12-48V DC
- ◆ DIP-switch for accurate digital-set of any time delay from 100ms to 10,230 seconds
- ◆ Two-terminal series-connection with the load
- ◆ Cost effective design & compact 2" x 2" enclosure are ideal for volume OEM applications
- ◆ Microprocessor-based design for greater performance & maximum flexibility
- ◆ Encapsulated for protection against harsh environments
- ◆ Output rated 1A continuous/10A inrush pilot duty is perfect for high duty cycle/long life applications



Better. By Design.

**800.238.7474**

**WWW.MACROMATIC.COM**

**SALES@MACROMATIC.COM**

The THL-8 On Delay Inline (Series Connection) offers an easy and accurate method to select any time delay. The THL-8 Series is a compact 2" x 2" encapsulated enclosure with a universal control voltage . It is connected in series with the load requiring only 2 terminals/connections.

Three time ranges are available: 0.1 – 102.3 seconds, 1 – 1,023 seconds and 10 – 10,230 seconds. Programming is accomplished through the use of a 10-position DIP-switch. Each position is marked with a binary time increment. The required delay is selected by moving the switch of each increment to the ON position and adding their corresponding values (see examples below). This method provides a greater setting accuracy than is found on other units with an analog potentiometer.

These products feature a universal control voltage of 24-240V AC and 12-48V DC. The inline two-terminal output is rated 1A continuous/10A inrush pilot duty, and is ideal for high duty cycle and long life applications. The enclosure is encapsulated for protection against harsh environments.

For similar products with choices of onboard and remote analog-set or fixed time delay, see the THL-1 Series.

FUNCTION ■	CONTROL VOLTAGE	CATALOG NUMBER **	WIRING
ON DELAY A	24-240V AC & 12-48V DC	THL-8024U-**	<p>DIAGRAM 329</p>

■ See "Definitions of Timing Functions".

\*\* Complete Product Number using two-digit Code from Table below.

## TIME DELAYS

**TIMING RANGE TABLE	
COMPLETE PRODUCT NUMBER USING TWO DIGIT CODE BELOW: i.e., THL-8024U-40	
Time Delay Range	Code
0.1 - 102.3 Sec.	40
1 - 1,023 Sec.	41
10 - 10,230 Sec.	42

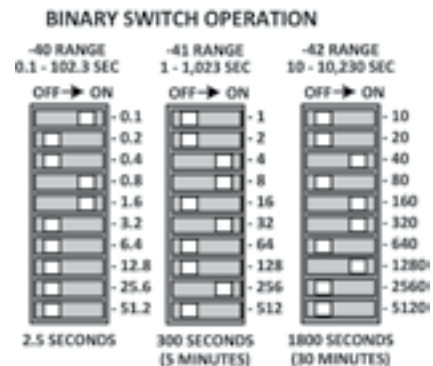

COMBINE FOR TOTAL TIME IN SECONDS

Build your Time Delay Relays with the [Online Product Builder](#)

# ON DELAY | INLINE (SERIES CONNECTION)

SOLID STATE OUTPUT | DIP-SWITCH DIGITAL-SET | THL-8 SERIES

## APPLICATION DATA

### Voltage Tolerance:

AC Operation: +10 to -15% of nominal voltage, 50/60 Hz  $\pm 5\%$   
DC Operation: +10 to -15% of nominal voltage

**Load (Burden):** Maximum of 1 VA for all voltages

### Setting Accuracy:

#### Constant Voltage & Temperature w/i specifications:

$\pm 2\%$  of set time or  $\pm 50\text{ms}$ , whichever is greater

#### For Variable Voltage & Temperature w/i specifications:

$\pm 5\%$  of set time or  $\pm 50\text{ms}$ , whichever is greater

### Repeat Accuracy:

#### Constant Voltage & Temperature w/i specifications:

$\pm 0.1\%$  of set time or  $\pm 0.02$  seconds, whichever is greater

#### For Variable Voltage & Temperature w/i specifications:

$\pm 1\%$  of set time or  $\pm 0.02$  seconds, whichever is greater

**Reset Time:** 50ms

### Start-up Time:

(Time from when power is applied until unit is timing)  
0.02 Seconds

### Maintain Function Time:

(Time unit continues to operate after power is removed)  
0.01 Seconds

**Temperature:** Operating:  $-40^\circ$  to  $65^\circ\text{C}$  ( $-40^\circ$  to  $149^\circ\text{F}$ )

Storage:  $-40^\circ$  to  $85^\circ\text{C}$  ( $-40^\circ$  to  $185^\circ\text{F}$ )

### Output Contacts:

Normally Open Solid State 1A Continuous, 10A Inrush @  $65^\circ\text{C}$ , Pilot Duty

### Life:

No predictable failure if used within operating parameters.

**Leakage Current (OFF-State):**  $< 5\text{ma}$  @ 240V AC

**Minimum Load Current:** 20ma

**Effective Voltage Drop (ON-State):** Maximum 3V @ 1A for all voltages

### Compatibility:

Using a solid state switch to initiate the time sequence is acceptable. See [www.macromatic.com/leakage](http://www.macromatic.com/leakage) or contact Macromatic for information regarding leakage current limits and other solid state design considerations.

### Mounting:

Surface with one #8 or #10 screw and a maximum tightening torque of 15 in-lbs.

### Termination:

0.25" male quick-connect terminals

### Approvals:



## DIMENSIONS

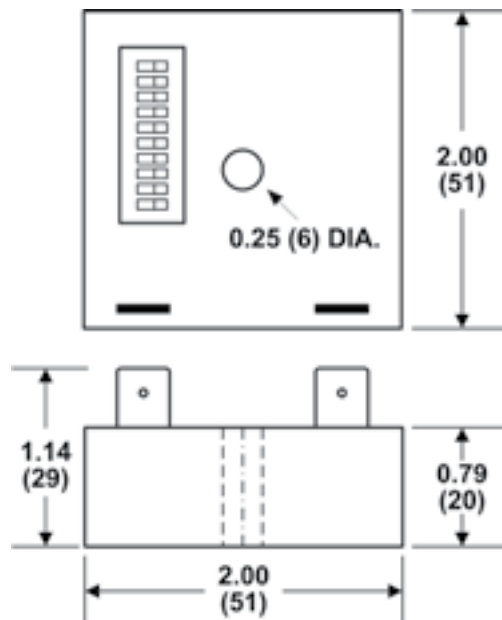

All Dimensions in  
Inches (Millimeters)

# NON-PROGRAMMABLE | ON DELAY, INTERVAL, TRUE OFF DELAY & FLASHER

## TR-5 SERIES



- ◆ Onboard & remote adjustable or fixed time delays from 0.05 seconds to 2 hours
- ◆ Uses industry-standard 8 pin octal sockets
- ◆ 10A DPDT output contacts
- ◆ Pilot duty rating



with appropriate socket

FUNCTION ■	Control voltage 50/60Hz.	CATALOG NUMBER **	WIRING/ SOCKETS ▲
<b>ON DELAY</b> A	120V AC/DC 12V DC 24V AC/DC 240V AC	TR-50222-** TR-50226-** TR-50228-** TR-50221-**	8 PIN OCTAL <b>70169-D</b>  <b>DIAGRAM 1</b>
<b>INTERVAL ON</b> B	120V AC/DC 12V DC 24V AC/DC 240V AC	TR-50522-** TR-50526-** TR-50528-** TR-50521-**	
<b>TRUE OFF DELAY</b> R	120V AC/DC 12V DC 24V AC/DC 240V AC	TR-50622-** TR-50626-** TR-50628-** TR-50621-**	
<b>FLASHER</b> (OFF 1st) E	120V AC/DC 12V DC 24V AC/DC 240V AC	TR-50822-** TR-50826-** TR-50828-** TR-50821-**	

■ See "Definitions of Timing Functions".

\*\* Complete Product Number using two-digit Code from Table below.

▲ Note: If these products are ordered with the Remote Adjustable Time Delay modification (suffix -Rx), they will require an 11 pin octal socket—see [www.macromatic.com/remote](http://www.macromatic.com/remote) for information. Remote Adjustable Time Delay not available on TR-506 products.

## TIME DELAYS

TR-5 Series Products have three time delay options:

- **Onboard Adjustable Time Delay**--complete Product Number by adding two-digit Code from Table at right, i.e., TR-50222-05 is an On Delay with a time delay range of 0.1-10 seconds.
- **Onboard Fixed Time Delay**--replace two-digit Code with suffix "F" followed by delay [0.1 ... 100] followed by (S) seconds, (M) minutes or (H) hours, i.e., TR-50222-F5S is an On Delay with a time delay fixed at 5 seconds.
- **Remote Adjustable Time Delay**--Selected TR-5 Series products can be built with two terminals for remote adjustable or fixed time delays. See [www.macromatic.com/remote](http://www.macromatic.com/remote) for information.

\*\* TIMING RANGE TABLE

Time Delay Range	Code
0.05 - 5 Sec.	04
0.1 - 10 Sec.	05
0.3 - 30 Sec.	07*
0.6 - 60 Sec.	08
1.2 - 120 Sec.	09
1.8 - 180 Sec.	10
3 - 300 Sec.	12
0.1 - 10 Min.	22
0.3 - 30 Min.	15
0.6 - 60 Min.	16*
1.2 - 120 Min.	17*

\* Not offered on TR-506

Sockets & Accessories available

Build your Time Delay Relays with the [Online Product Builder](#)



Better. By Design.

800.238.7474

WWW.MACROMATIC.COM

SALES@MACROMATIC.COM

# NON-PROGRAMMABLE | OFF DELAY, SINGLE SHOT, WATCHDOG & SINGLE SHOT FALLING EDGE

## TR-5 SERIES

FUNCTION ■ ▲	CONTROL VOLTAGE 50/60Hz.	CATALOG NUMBER **	WIRING/ SOCKETS ▲
<b>OFF DELAY</b> Control Switch Trigger C	120V AC/DC 12V DC 24V AC/DC 240V AC	TR-51622-** TR-51626-** TR-51628-** TR-51621-**	<p>DIAGRAM 2</p>
<b>SINGLE SHOT</b> Control Switch Trigger D	120V AC/DC 12V DC 24V AC/DC 240V AC	TR-51522-** TR-51526-** TR-51528-** TR-51521-**	
<b>WATCHDOG</b> Control Switch Trigger (Retriggerable Single Shot) J	120V AC/DC 12V DC 24V AC/DC 240V AC	TR-51322-** TR-51326-** TR-51328-** TR-51321-**	
<b>SINGLE SHOT FALLING EDGE</b> Control Switch Trigger H	120V AC/DC 12V DC 24V AC/DC 240V AC	TR-52222-** TR-52226-** TR-52228-** TR-52221-**	
<b>OFF DELAY</b> Power Trigger C	120V AC/DC 12V DC 24V AC/DC 240V AC	TR-51922-** TR-51926-** TR-51928-** TR-51921-**	<p>DIAGRAM 4</p>
<b>SINGLE SHOT</b> Power Trigger D	120V AC/DC 12V DC 24V AC/DC 240V AC	TR-51722-** TR-51726-** TR-51728-** TR-51721-**	
<b>WATCHDOG</b> Power Trigger (Retriggerable Single Shot) J	120V AC/DC 12V DC 24V AC/DC 240V AC	TR-51822-** TR-51826-** TR-51828-** TR-51821-**	



- ◆ Onboard & remote adjustable or fixed time delays from 0.05 seconds to 2 hours
- ◆ Uses industry-standard 11 pin octal sockets
- ◆ 10A DPDT output contacts
- ◆ Pilot duty rating



■ See "Definitions of Timing Functions".

\*\* Complete Product Number using two-digit Code from Table below.

▲ 8 Pin SPDT versions of these functions (except Single Shot Falling Edge) are available.

## TIME DELAYS

TR-5 Series Products have three time delay options:

- **Onboard Adjustable Time Delay**--complete Product Number by adding two-digit Code from Table at right, i.e., TR-51622-05 is an Off Delay with a time delay range of 0.1-10 seconds.
- **Onboard Fixed Time Delay**--replace two-digit Code with suffix "F" followed by delay [0.1 ... 100] followed by (S) seconds, (M) minutes or (H) hours, i.e., TR-51622-F5S is an Off Delay with a time delay fixed at 5 seconds.
- **Remote Time Delay**--Selected TR-5 Series products can be built with two terminals for remote adjustable or fixed time delays. See [www.macromatic.com/remote](http://www.macromatic.com/remote) for information.

** TIMING RANGE TABLE	
Time Delay Range	Code
0.05 - 5 Sec.	04
0.1 - 10 Sec.	05
0.3 - 30 Sec.	07
0.6 - 60 Sec.	08
1.2 - 120 Sec.	09
1.8 - 180 Sec.	10
3 - 300 Sec.	12
0.1 - 10 Min.	22
0.3 - 30 Min.	15
0.6 - 60 Min.	16
1.2 - 120 Min.	17

Sockets & Accessories available

Build your Time Delay Relays with the [Online Product Builder](#)



Better. By Design.

800.238.7474

WWW.MACROMATIC.COM

SALES@MACROMATIC.COM

# NON-PROGRAMMABLE | REPEAT CYCLE, ON/OFF DELAY, & DELAYED INTERVAL

## TR-5 SERIES



- ◆ Onboard & remote adjustable or fixed time delays from 0.05 seconds to 2 hours
- ◆ Independently adjustable ON & OFF times
- ◆ Uses industry-standard 8 or 11 pin octal sockets
- ◆ 10A DPDT output contacts
- ◆ Pilot duty rating

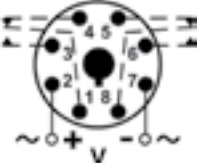
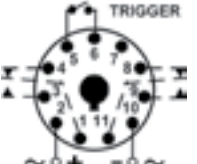

with appropriate socket

FUNCTION ■	CONTROL VOLTAGE 50/60Hz.	CATALOG NUMBER **	WIRING/SOCKET
<b>REPEAT CYCLE*</b> (OFF Time First Followed By ON Time and Repeating) <b>L</b>	120V AC/DC 12V DC 24V AC/DC 240V AC	TR-53122-** TR-53126-** TR-53128-** TR-53121-**	8 PIN OCTAL <b>70169-D</b> 
<b>ON/TRUE OFF DELAY</b> <b>S</b>	120V AC/DC 12V DC 24V AC/DC 240V AC	TR-54622-** TR-54626-** TR-54628-** TR-54621-**	<b>DIAGRAM 1</b>
<b>REPEAT CYCLE*</b> (ON Time First Followed By OFF Time and Repeating) <b>M</b>	120V AC/DC 12V DC 24V AC/DC 240V AC	TR-55122-** TR-55126-** TR-55128-** TR-55121-**	
<b>DELAYED INTERVAL*</b> (OFF Time Followed by ON Time Followed by OFF State Until Reset) <b>N</b>	120V AC/DC 12V DC 24V AC/DC 240V AC	TR-56122-** TR-56126-** TR-56128-** TR-56121-**	
<b>ON/OFF DELAY*</b> Control Switch Trigger <b>G</b>	120V AC/DC 12V DC 24V AC/DC 240V AC	TR-54122-** TR-54126-** TR-54128-** TR-54121-**	11 PIN OCTAL <b>70170-D</b> 
<b>DELAYED INTERVAL*</b> Control Switch Trigger (OFF Time Followed by ON Time Followed by OFF State Until Reset) <b>P</b>	120V AC/DC 12V DC 24V AC/DC 240V AC	TR-56522-** TR-56526-** TR-56528-** TR-56521-**	<b>DIAGRAM 2</b>

■ See "Definitions of Timing Functions".

\* ON & OFF Time Ranges for these functions are the same. See [www.macromatic.com/onoff](http://www.macromatic.com/onoff) for information on how to order a unit with different ON & OFF time ranges.

\*\* Complete Product Number using two-digit Code from Table below.

## TIME DELAYS

TR-5 Series Products have three time delay options:

- **Onboard Adjustable Time Delay**--complete Product Number by adding two-digit Code from Table at right, i.e., TR-53122-05 is a Repeat Cycle with both an ON & OFF time delay range of 0.1-10 seconds. See [www.macromatic.com/onoff](http://www.macromatic.com/onoff) for information on how to order a unit with different ON & OFF time ranges.
- **Onboard Fixed Time Delay**--replace two-digit Code with suffix "F" followed by delay [0.1 ... 100] followed by (S) seconds, (M) minutes or (H) hours, i.e., TR-53122-F5S is a Repeat Cycle with a time delay fixed at 5 seconds.
- **Remote Time Delay**--Selected TR-5 Series products can be built with two terminals for remote adjustable or fixed time delays. See [www.macromatic.com/remotec](http://www.macromatic.com/remotec) for information.

### \*\* TIMING RANGE TABLE

Time Delay Range	Code
0.05 - 5 Sec.	04
0.1 - 10 Sec.	05
0.3 - 30 Sec.	07*
0.6 - 60 Sec.	08
1.2 - 120 Sec.	09
1.8 - 180 Sec.	10
3 - 300 Sec.	12
0.1 - 10 Min.	22
0.3 - 30 Min.	15
0.6 - 60 Min.	16*
1.2 - 120 Min.	17*

\* Not offered on TR-546

Sockets & Accessories available

Build your Time Delay Relays with the [Online Product Builder](#)



Better. By Design.

800.238.7474

WWW.MACROMATIC.COM

SALES@MACROMATIC.COM

# TR-5 SERIES

## NON-PROGRAMMABLE

### APPLICATION DATA

#### Voltage Tolerance:

AC Operation: +10/-15% of nominal at 50/60 Hz.  
 DC Operation: +10/-15% of nominal.

#### Load (Burden):

Maximum of 2 VA for all voltages

#### Setting Accuracy:

Maximum Setting (Adjustable): +5%, -0%  
 Minimum Setting (Adjustable): +0%, -50%  
 Fixed Time Delay: ±2% or 50ms, whichever is greater

**Repeat Accuracy** (constant voltage and temperature):  
 ±0.1% or ± 0.04 seconds, whichever is greater

#### Reset Time:

Control voltage (All Functions) 0.100 Seconds  
 Triggered Functions only 0.04 Seconds

#### Start-up Time:

(Time from when power is applied until unit is timing)  
 0.05 Seconds

#### Maintain Function Time:

(Time unit continues to operate after power is removed)  
 0.01 Seconds for all units

**Temperature:** Operating: -28° to 65°C (-18° to 149°F)  
 Storage: -40° to 85°C (-40° to 185°F)

#### Output Contacts:

(All TR-5 Series Products except TR-506 & TR-546)  
 DPDT 10A @ 240V AC/30V DC,  
 1/2HP @ 120/240V AC (N.O.), 1/3HP @ 120/240V AC (N.C.)  
 B300 & R300; AC15 & DC13

(TR-506 & TR-546)

DPDT 10A @ 240V AC; 8A @ 28V DC,  
 1/2 HP @ 240V AC, 1/4HP @ 120V AC  
 B300 & R300

#### Life:

Mechanical: 10,000,000 operations (2,000,000 operations  
 on TR-506 & TR-546 Series only)  
 Full Load: 100,000 operations

#### Compatibility:

Using a solid state switch to initiate the time sequence is acceptable. See [www.macromatic.com/leakage](http://www.macromatic.com/leakage) or contact Macromatic for information regarding leakage current limits and other solid state design considerations.

#### Triggering Off Delay, Single Shot or Watchdog Units:

Timing sequence must be initiated only after control voltage is applied to unit. Minimum required trigger switch closure time is 0.05 seconds.

**IMPORTANT FOR TR-506 & TR-546 SERIES ONLY:** These relays are shipped from the factory in the OFF state. A shock to the relay during shipping or installation may cause it to change to the ON state. It is recommended that control voltage be applied to the product for at least 0.1 second and removed to cycle the unit to the OFF state prior to use in the application. Please note that it will take as long as the OFF Delay setting to reset the unit once control voltage has been removed.

#### Approvals:

(All TR-5 Series Products  
 except TR-506 & TR-546)



(TR-506 & TR-546 only)



(All TR-5 Series  
 Products)



### DIMENSIONS

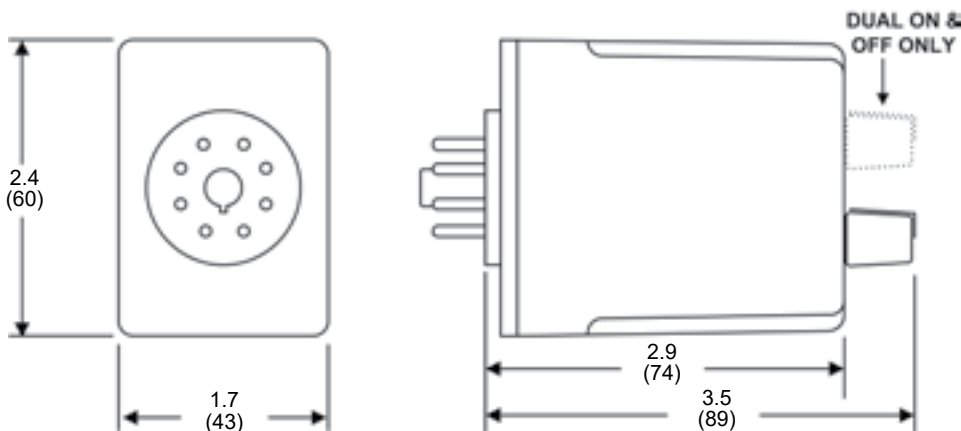

All Dimensions in Inches (Millimeters)

# NON-PROGRAMMABLE | OFF DELAY, SINGLE SHOT & WATCHDOG

## 8 PIN | SPDT VERSIONS | TR-5 SERIES



- ◆ These are 8 pin 10A SPDT versions of our standard 11 pin DPDT products
- ◆ Onboard & remote adjustable or fixed time delays from 0.05 seconds to 2 hours
- ◆ Uses industry-standard 8 pin octal socket
- ◆ Pilot duty rating

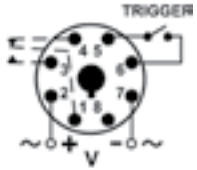
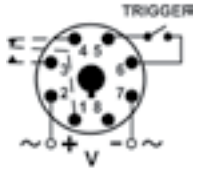
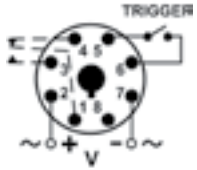
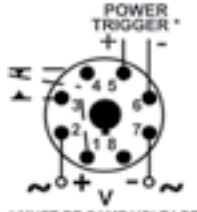
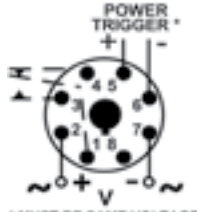
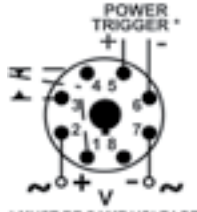

with appropriate socket

FUNCTION ■	CONTROL VOLTAGE 50/60Hz.	CATALOG NUMBER **	WIRING/ SOCKETS ▲
<b>OFF DELAY</b> Control Switch Trigger ■	120V AC/DC 12V DC 24V AC/DC 240V AC	TR-51662-** TR-51666-** TR-51668-** TR-51661-**	8 PIN OCTAL 70169-D ▲ 
<b>SINGLE SHOT</b> Control Switch Trigger ■	120V AC/DC 12V DC 24V AC/DC 240V AC	TR-51562-** TR-51566-** TR-51568-** TR-51561-**	
<b>WATCHDOG</b> Control Switch Trigger (Retriggerable Single Shot) ■	120V AC/DC 12V DC 24V AC/DC 240V AC	TR-51362-** TR-51366-** TR-51368-** TR-51361-**	
<b>OFF DELAY</b> Power Trigger ■	120V AC/DC 12V DC 24V AC/DC 240V AC	TR-51962-** TR-51966-** TR-51968-** TR-51961-**	8 PIN OCTAL 70169-D ▲ 
<b>SINGLE SHOT</b> Power Trigger ■	120V AC/DC 12V DC 24V AC/DC 240V AC	TR-51762-** TR-51766-** TR-51768-** TR-51761-**	
<b>WATCHDOG</b> Power Trigger (Retriggerable Single Shot) ■	120V AC/DC 12V DC 24V AC/DC 240V AC	TR-51862-** TR-51866-** TR-51868-** TR-51861-**	

■ See "Definitions of Timing Functions".

\*\* Complete Product Number using two-digit Code from Table below.

▲ Note: if these products are ordered with the Remote Adjust Potentiometer modification (suffix -Rx), they will require an 11 pin octal socket—see [www.macromatic.com/remote](http://www.macromatic.com/remote) for information.

### TIME DELAYS

TR-5 Series Products have three time delay options:

- **Onboard Adjustable Time Delay**--complete Product Number by adding two-digit Code from Table at right, i.e., TR-51662-05 is an Off Delay with a time delay range of 0.1-10 seconds.
- **Onboard Fixed Time Delay**--replace two-digit Code with suffix "F" followed by delay [0.1 ... 100] followed by (S) seconds, (M) minutes or (H) hours, i.e., TR-51662-F5S is an Off Delay with a time delay fixed at 5 seconds.
- **Remote Time Delay**--Selected TR-5 Series products can be built with two terminals for remote adjustable or fixed time delays. See [www.macromatic.com/remote](http://www.macromatic.com/remote) for information.

\*\* TIMING RANGE TABLE

Time Delay Range	Code
0.05 - 5 Sec.	04
0.1 - 10 Sec.	05
0.3 - 30 Sec.	07
0.6 - 60 Sec.	08
1.2 - 120 Sec.	09
1.8 - 180 Sec.	10
3 - 300 Sec.	12
0.1 - 10 Min.	22
0.3 - 30 Min.	15
0.6 - 60 Min.	16
1.2 - 120 Min.	17

Sockets & Accessories available

Build your Time Delay Relays with the [Online Product Builder](#)



Better. By Design.

800.238.7474

WWW.MACROMATIC.COM

SALES@MACROMATIC.COM



# NON-PROGRAMMABLE | OFF DELAY, SINGLE SHOT & WATCHDOG

## 8 PIN | SPDT VERSIONS | TR-5 SERIES

### APPLICATION DATA

#### Voltage Tolerance:

AC Operation: +10/-15% of nominal at 50/60 Hz.  
DC Operation: +10/-15% of nominal.

#### Load (Burden):

Maximum of 2 VA for all voltages

#### Setting Accuracy:

Maximum Setting (Adjustable): +5%, -0%  
Minimum Setting (Adjustable): +0%, -50%  
Fixed Time Delay:  $\pm 2\%$  or 50ms, whichever is greater

**Repeat Accuracy** (constant voltage and temperature):  
 $\pm 0.1\%$  or  $\pm 0.04$  seconds, whichever is greater

#### Reset Time:

Control voltage (All Functions) 0.100 Seconds  
Triggered Functions only 0.04 Seconds

#### Start-up Time:

(Time from when power is applied until unit is timing)  
0.05 Seconds

#### Maintain Function Time:

(Time unit continues to operate after power is removed)  
0.01 Seconds for all units

**Temperature:** Operating: -28° to 65°C (-18° to 149°F)  
Storage: -40° to 85°C (-40° to 185°F)

#### Output Contacts:

SPDT 10A @ 240V AC/30V DC,  
1/2HP @ 120/240V AC (N.O.), 1/3HP @ 120/240V AC (N.C.)  
B300 & R300; AC15 & DC13

#### Life:

Mechanical: 10,000,000 operations  
Full Load: 100,000 operations

#### Compatibility:

Using a solid state switch to initiate the time sequence is acceptable. See [www.macromatic.com/leakage](http://www.macromatic.com/leakage) or contact Macromatic for information regarding leakage current limits and other solid state design considerations.

#### Triggering Off Delay, Single Shot or Watchdog Units:

Timing sequence must be initiated only after control voltage is applied to unit. Minimum required trigger switch closure time is 0.05 seconds.

#### Approvals:



### DIMENSIONS

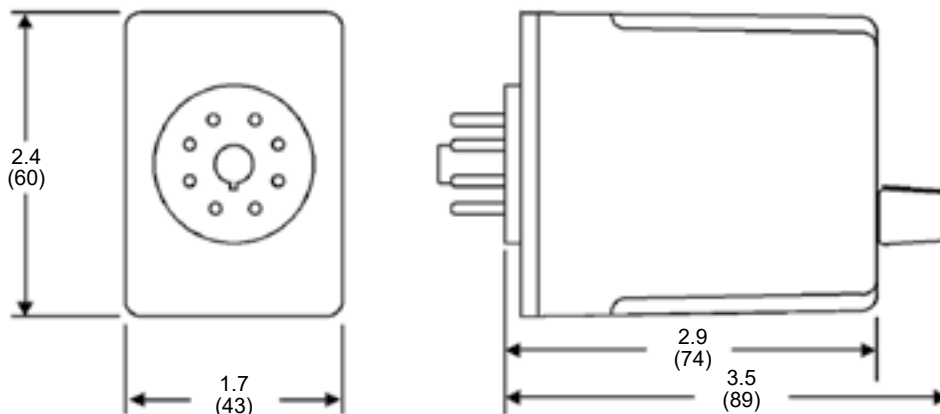

All Dimensions in Inches (Millimeters)

# PROGRAMMABLE | MULTI-FUNCTION

## TR-6 SERIES TIME RANGER™



- ◆ Four or eight timing functions in one unit easily selectable with rotary switch
- ◆ Each unit has 16 timing ranges built-in covering 0.05 seconds-100 hours
- ◆ Selecting a range is easy using a 16-position rotary switch (no math is required or DIP switches to set)
- ◆ Universal control voltage : 24-240V AC & 12-125V DC
- ◆ Utilizes industry-standard 8 or 11 pin octal sockets
- ◆ 10A SPDT or DPDT output contacts can handle most pilot duty and fractional HP loads



**800.238.7474**  
**WWW.MACROMATIC.COM**  
**SALES@MACROMATIC.COM**

The TR-681 & TR-682 Series offer the flexible programmability of a multi-function and multi-range time delay relay together with a universal control voltage . These products provide an easy method to select one of eight (TR-681) or four (TR-682) time delay functions and any time range between 0.05 seconds and 100 hours. Programming is accomplished through the use of two rotary switches to select function and time range. The actual time delay is then set by using the potentiometer to adjust within the selected time range. This product can literally replace hundreds of different catalog numbers, thereby reducing inventory requirements.

FUNCTION ■	OUTPUT	Control Volt- age 50/60Hz.	CATALOG NUMBER	WIRING/ SOCKETS
<b>ON DELAY INTERVAL ON OFF DELAY SINGLE SHOT FLASHER (ON 1st) SINGLE SHOT (Falling Edge) WATCHDOG ON DELAY (Triggered)</b>	11 Pin DPDT	24-240V AC & 12-125V DC	TR-6812U	11 PIN OCTAL <b>70170-D</b>  <b>DIAGRAM 210</b>
	8 Pin SPDT	24-240V AC & 12-125V DC	TR-6816U	8 PIN OCTAL <b>70169-D</b>  <b>DIAGRAM 211</b>
<b>ON DELAY INTERVAL ON FLASHER (OFF 1st) FLASHER (ON 1st)</b>	8 Pin DPDT	24-240V AC & 12-125V DC	TR-6822U	8 PIN OCTAL <b>70169-D</b>  <b>DIAGRAM 212</b>

■ See "Definitions of Timing Functions".

### TIMING RANGES

Select one of the 16 built-in time ranges by setting the rotary switch per a chart on the unit (see right) and then adjust within that range using the knob on top.

Dial Setting	Timing Range	Dial Setting	Timing Range
A	0.05 - 0.5 Sec.	I	1 - 10 Min.
B	0.1 - 1 Sec.	J	3 - 30 Min.
C	0.5 - 5 Sec.	K	6 - 60 Min.
D	1 - 10 Sec.	L	0.2 - 2 Hr.
E	3 - 30 Sec.	M	0.5 - 5 Hr.
F	6 - 60 Sec.	N	1 - 10 Hr.
G	0.2 - 2 Min.	O	2.4 - 24 Hr.
H	0.5 - 5 Min.	P	10 - 100 Hr.

Sockets & Accessories available

Build your Time Delay Relays with the [Online Product Builder](#)

# PROGRAMMABLE | MULTI-FUNCTION

## TR-6 SERIES TIME RANGER™

### PROGRAMMING FUNCTION & TIME DELAY

**Setting Function:** To set the function, first select one of the eight (TR-681 Series) or four (TR-682 Series) functions from the Select Function Chart located on the side of the relay (see right). Position the eight-position rotary switch to the number that corresponds to the desired function. **NOTE:** Because the TR-682 Series comes with only four functions, but uses an eight-position rotary switch to select a function, each function can be selected with the same number in two positions. **NOTE: Function cannot be changed with power applied to unit.**

**Setting Time Delay and Time Range:** To set the desired time delay, first select one of the 16 time ranges from the Timing Range Chart located on the side of the relay. Position the rotary switch to the letter that corresponds to the desired time range. Then adjust the time delay within the selected time range by rotating the large knob of the potentiometer located on top of the unit. **Note:** The tick marks are for reference only.

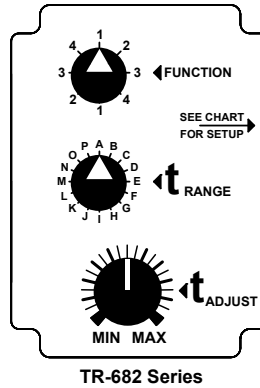
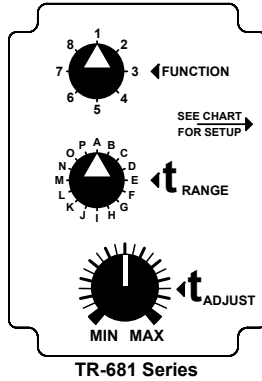

#### TR-681 Series

Select Function	
1	On Delay
2	Interval On
3	Flasher - On 1st
4	Triggered On Delay
5	Watchdog
6	Single Shot
7	Off Delay
8	One Shot Falling Edge

#### TR-682 Series

Select Function	
1	On Delay
2	Interval On
3	Flasher - Off 1st
4	Flasher - On 1st

### APPLICATION DATA

#### Voltage Tolerance:

AC Operation: 20.4 – 264V at 50/60 Hz  
DC Operation: 10.2 – 137.5V

#### Load (Burden):

Maximum of 3 VA for all voltages

#### Setting Accuracy:

Maximum Setting (Adjustable): +5%, -0%  
Minimum Setting (Adjustable): +0%, -50%

#### Repeat Accuracy (constant voltage and temperature):

±0.1% or ±50ms, whichever is greater

#### Reset Time:

Functions Triggered with Control voltage : 0.1 Seconds  
Functions Triggered with Control Switch: 0.04 Seconds

**Start-up Time:** (Time from when power is applied until unit is timing): 50ms

**Maintain Function Time:** (Time unit continues to operate after power is removed): 0.01 Seconds

#### Temperature:

Operating: -28° to 65°C (-18° to 150°F)  
Storage: -40° to 85°C (-40° to 185°F)

#### Functions Triggered By A Control Switch:

Minimum required trigger switch closure time is 50ms.

#### Compatibility:

Using a solid state switch to initiate the time sequence is acceptable. See [www.macromatic.com/leakage](http://www.macromatic.com/leakage) or contact Macromatic for information regarding leakage current limits and other solid state design considerations.

#### Output Contacts:

10A @ 240V AC/30V DC,  
1/2HP @ 120/240V AC (N.O.), 1/3HP @ 120/240V AC (N.C.)  
B300 & R300 (N.O.); AC15 & DC13

#### Life:

Mechanical: 10,000,000 operations  
Full Load: 100,000 operations

#### Approvals:



Low Voltage & EMC Directives  
EN60947-1, EN60947-5-1

### DIMENSIONS

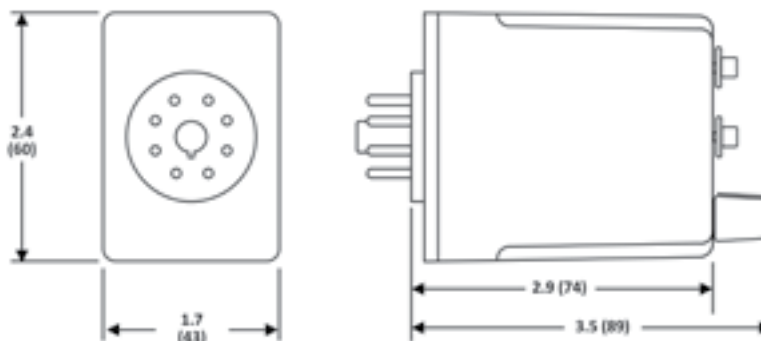

All Dimensions in Inches (Millimeters)

# PROGRAMMABLE | MULTI-RANGE ON DELAY, INTERVAL ON & FLASHER

## TR-6 SERIES TIME RANGER™

The TR-6 Series offers the flexible programmability of a multi-range time delay relay together with a universal control voltage. These products provide an easy method to select one of 16 time ranges between 0.05 seconds and 100 hours using a rotary switch. The actual time delay is then set by using the potentiometer to adjust within the selected time range.



- ◆ Each unit has 16 timing ranges built-in covering 0.05 seconds-100 hours
- ◆ Selecting a range is easy using a rotary switch (no math is required or DIP switches to set)
- ◆ Universal control voltage : 24-240V AC & 12-125V DC
- ◆ Uses industry-standard 8 pin octal sockets
- ◆ 10A DPDT output contacts can handle most pilot duty & fractional HP loads

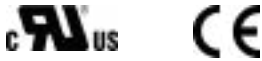

Better. By Design.

**800.238.7474**

**WWW.MACROMATIC.COM**

**SALES@MACROMATIC.COM**

FUNCTION ■	CONTROL VOLTAGE 50/60Hz.	CATALOG NUMBER	WIRING/ SOCKETS
<b>ON DELAY</b> <b>A</b>	24-240V AC & 12-125V DC	TR-6022U	<p><b>DIAGRAM 1</b></p>
<b>INTERVAL ON</b> <b>B</b>	24-240V AC & 12-125V DC	TR-6052U	
<b>FLASHER</b> (OFF 1st) <b>E</b>	24-240V AC & 12-125V DC	TR-6082U	
<b>FLASHER</b> (ON 1st) <b>F</b>	24-240V AC & 12-125V DC	TR-6092U	

■ See "Definitions of Timing Functions".

## TIMING RANGES

Select one of the 16 built-in time ranges by setting the rotary switch per a chart on the unit (see below) and then adjust within that range using the knob on top.

Dial Setting	Timing Range
A	0.05 - 0.5 Sec.
B	0.1 - 1 Sec.
C	0.5 - 5 Sec.
D	1 - 10 Sec.
E	3 - 30 Sec.
F	6 - 60 Sec.
G	0.2 - 2 Min.
H	0.5 - 5 Min.
I	1 - 10 Min.
J	3 - 30 Min.
K	6 - 60 Min.
L	0.2 - 2 Hr.
M	0.5 - 5 Hr.
N	1 - 10 Hr.
O	2.4 - 24 Hr.
P	10 - 100 Hr.

Sockets & Accessories available

Build your Time Delay Relays with the [Online Product Builder](#)

# PROGRAMMABLE | MULTI-RANGE OFF DELAY, SINGLE SHOT & WATCHDOG TR-6 SERIES TIME RANGER™

The TR-6 Series offers the flexible programmability of a multi-range time delay relay together with a universal control voltage. These products provide an easy method to select one of 16 time ranges between 0.05 seconds and 100 hours using a rotary switch. The actual time delay is then set by using the potentiometer to adjust within the selected time range.

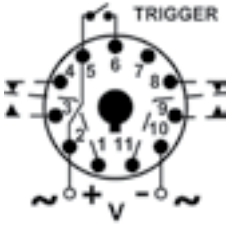
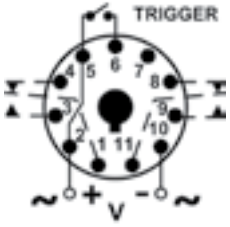
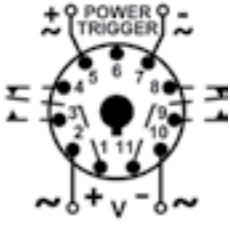
FUNCTION ■	CONTROL VOLTAGE 50/60Hz.	CATALOG NUMBER	WIRING/SOCKETS
<b>OFF DELAY ▲</b> Control Switch Trigger ■	24-240V AC & 12-125V DC	TR-6162U	11 PIN OCTAL 70170-D 
<b>SINGLE SHOT</b> Control Switch Trigger ■	24-240V AC & 12-125V DC	TR-6152U	 <b>DIAGRAM 212</b>
<b>WATCHDOG</b> Control Switch Trigger (Retriggerable Single Shot) ■	24-240V AC & 12-125V DC	TR-6132U	
<b>OFF DELAY ▲</b> Power Trigger ■	24-240V AC & 12-125V DC	TR-6192U	
<b>SINGLE SHOT</b> Power Trigger ■	24-240V AC & 12-125V DC	TR-6172U	 <b>DIAGRAM 216</b>
<b>WATCHDOG</b> Power Trigger (Retriggerable Single Shot) ■	24-240V AC & 12-125V DC	TR-6182U	

■ See "Definitions of Timing Functions".

▲ See TR-606 Series for True Off Delay function.

## TIMING RANGES

Select one of the 16 built-in time ranges by setting the rotary switch per a chart on the unit (see below) and then adjust within that range using the knob on top.

Dial Setting	Timing Range
A	0.05 - 0.5 Sec.
B	0.1 - 1 Sec.
C	0.5 - 5 Sec.
D	1 - 10 Sec.
E	3 - 30 Sec.
F	6 - 60 Sec.
G	0.2 - 2 Min.
H	0.5 - 5 Min.
I	1 - 10 Min.
J	3 - 30 Min.
K	6 - 60 Min.
L	0.2 - 2 Hr.
M	0.5 - 5 Hr.
N	1 - 10 Hr.
O	2.4 - 24 Hr.
P	10 - 100 Hr.

Sockets & Accessories available



- ◆ Each unit has 16 timing ranges built-in covering 0.05 seconds-100 hours
- ◆ Selecting a range is easy using a rotary switch (no math is required or DIP switches to set)
- ◆ Universal control voltage : 24-240V AC & 12-125V DC
- ◆ Uses industry-standard 11 pin octal sockets
- ◆ 10A DPDT output contacts can handle most pilot duty & fractional HP loads



Better. By Design.

800.238.7474

WWW.MACROMATIC.COM

SALES@MACROMATIC.COM

Build your Time Delay Relays with the [Online Product Builder](#)

# PROGRAMMABLE | MULTI-RANGE REPEAT CYCLE & DELAYED INTERVAL

## TR-6 SERIES TIME RANGER™

The TR-6 Series offers the flexible programmability of a multi-range time delay relay together with a universal control voltage. These products provide an easy method to select one of 16 time ranges between 0.05 seconds and 100 hours using a rotary switch. The actual time delay is then set by using the potentiometer to adjust within the selected time range.



- ◆ Each unit has 16 timing ranges built-in covering 0.05 seconds-100 hours
- ◆ Selecting a range is easy using a rotary switch (no math is required or DIP switches to set)
- ◆ Independently selectable & adjustable ON & OFF times
- ◆ Universal control voltage : 24-240V AC & 12-125V DC
- ◆ Uses industry-standard 8 or 11 pin octal sockets
- ◆ 10A DPDT output contacts can handle most pilot duty & fractional HP loads

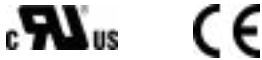

Better. By Design.

**800.238.7474**

**WWW.MACROMATIC.COM**

**SALES@MACROMATIC.COM**

FUNCTION ■	CONTROL VOLTAGE 50/60Hz.	CATALOG NUMBER	WIRING/SOCKET
<b>REPEAT CYCLE*</b> (OFF Time First Followed By ON Time and Repeating) <b>L</b>	24-240V AC & 12-125V DC	TR-6312U	8 PIN OCTAL <b>70169-D</b>
<b>REPEAT CYCLE*</b> (ON Time First Followed By OFF Time and Repeating) <b>M</b>	24-240V AC & 12-125V DC	TR-6512U	 <b>DIAGRAM 1</b>
<b>DELAYED INTERVAL*</b> (OFF Time Followed by ON Time Followed by OFF State Until Reset) <b>N</b>	24-240V AC & 12-125V DC	TR-6612U	<b>DIAGRAM 1</b>
<b>DELAYED INTERVAL*</b> Control Switch Trigger (OFF Time Followed by ON Time Followed by OFF State Until Reset) <b>P</b>	24-240V AC & 12-125V DC	TR-6652U	11 PIN OCTAL <b>70170-D</b>  <b>DIAGRAM 212</b>

\* These units have independently selectable & adjustable ON & OFF times. See [www.macromatic.com/onoff](http://www.macromatic.com/onoff) for more information.

■ See "Definitions of Timing Functions".

## TIMING RANGES

Select one of the 16 built-in time ranges by setting the rotary switch per a chart on the unit (see below) and then adjust within that range using the knob on top.

Dial Setting	Timing Range
A	0.05 - 0.5 Sec.
B	0.1 - 1 Sec.
C	0.5 - 5 Sec.
D	1 - 10 Sec.
E	3 - 30 Sec.
F	6 - 60 Sec.
G	0.2 - 2 Min.
H	0.5 - 5 Min.
I	1 - 10 Min.
J	3 - 30 Min.
K	6 - 60 Min.
L	0.2 - 2 Hr.
M	0.5 - 5 Hr.
N	1 - 10 Hr.
O	2.4 - 24 Hr.
P	10 - 100 Hr.

Sockets & Accessories available

Build your Time Delay Relays with the [Online Product Builder](#)

# PROGRAMMABLE | MULTI-RANGE

## TR-6 SERIES TIME RANGER™

### APPLICATION DATA

**Voltage Tolerance:**

AC Operation: 20.4 – 264V at 50/60 Hz  
DC Operation: 10.2 – 137.5V

**Load (Burden):**

Maximum of 3 VA for all voltages

**Setting Accuracy:**

Maximum Setting (Adjustable): +5%, -0%  
Minimum Setting (Adjustable): +0%, -50%

**Repeat Accuracy** (constant voltage and temperature):

±0.1% or ±50ms, whichever is greater

**Reset Time:**

Functions Triggered with Control voltage : 0.1 Seconds  
Functions Triggered with Control Switch: 0.04 Seconds

**Start-up Time:**

(Time from when power is applied until unit is timing)  
0.05 Seconds

**Maintain Function Time:**

(Time unit continues to operate after power is removed)  
0.01 Seconds

**Temperature:**

Operating: -28° to 65°C (-18° to 150°F)  
Storage: -40° to 85°C (-40° to 185°F)

**Triggering Off Delay, Single Shot or Watchdog Units:**

Timing sequence must be initiated only after control voltage is applied to unit. Minimum required trigger switch closure time is 0.1 seconds.

**Compatibility:**

Using a solid state switch to initiate the time sequence is acceptable. See [www.macromatic.com/leakage](http://www.macromatic.com/leakage) or contact Macromatic for information regarding leakage current limits and other solid state design considerations.

**Output Contacts:**

DPDT 10A @ 240V AC/30V DC,  
1/2HP @ 120/240V AC (N.O.), 1/3HP @ 120/240V AC (N.C.)  
B300 & R300 (N.O.); AC15 & DC13

**Life:**

Mechanical: 10,000,000 operations  
Full Load: 100,000 operations

**Approvals:**

Low Voltage &  
EMC Directives  
EN60947-1, EN60947-5-1

### DIMENSIONS

TR-602, TR-605, TR608, TR609, TR-613, TR-615, TR-616,  
TR-617, TR-618 & TR-619

TR-631-TR-651, TR-661 & TR-665

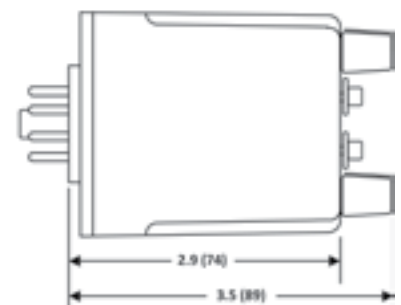
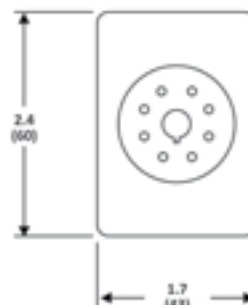
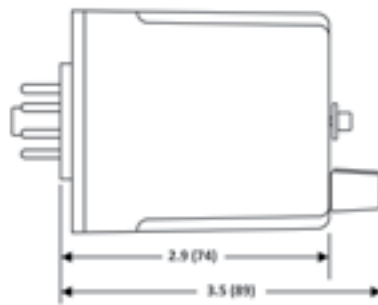
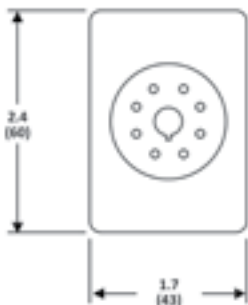

All Dimensions in  
Inches (Millimeters)

# PROGRAMMABLE | MULTI-RANGE TRUE OFF DELAY

## TR-6 SERIES TIME RANGER™



- ◆ Each unit has 8 timing built-in covering 0.05 seconds - 30 minutes
- ◆ Selecting a range is easy using a rotary switch (no math is required or DIP switches to set)
- ◆ Uses industry-standard 8 pin octal sockets
- ◆ 10A DPDT output contacts can handle most pilot duty & fractional HP loads



A True Off Delay time delay relay is designed to replace the functionality of pneumatic time delay relays which are very large, expensive and not very accurate. Unlike standard electronic Off Delay time delay relays (see page 29), a True Off Delay does not require a trigger switch or the continuous application of control voltage. Instead, these products keep the logic circuit and relay energized during the Off Delay (Delay on De-energization) period with an onboard power source.

The Macromatic TR-606 Series is a perfect product to use when a trigger switch is not available in the circuit or when the application is to replace the functionality of a pneumatic time delay relay. These products come with 8 separate timing ranges covering 0.5 seconds – 30 minutes which are easy to select & setup with one rotary switch & potentiometer.

**Operation:** Upon application of control voltage, the output is energized. When the control voltage is removed, the time delay (t) begins. At the end of the time delay (t), the output is de-energized.

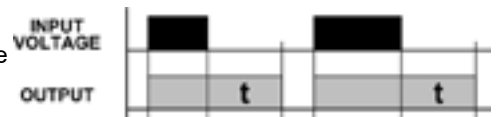

Control voltage must be applied for a minimum of 0.5 seconds to assure proper operation. Any application of the control voltage during the time delay (t) will reset the time delay. No external trigger is required.

FUNCTION ■	Control voltage 50/60Hz.	CATALOG NUMBER	WIRING/SOCKETS
TRUE OFF DELAY	120V AC/DC 12V DC 24V AC/DC 240V AC 48V AC/DC	TR-60622 TR-60626 TR-60628 TR-60621 TR-60624	8 PIN OCTAL 70169-D  DIAGRAM 1

■ See "Definitions of Timing Functions".

## TIMING RANGES

Select one of the 8 built-in time ranges by setting the rotary switch per a chart on the unit (see below) and adjust within that range using the knob on top:

Dial Setting	Timing Range
A	0.05 - 5 Sec.
B	0.1 - 10 Sec.
C	0.3 - 30 Sec.
D	0.6 - 60 Sec.
E	1.8 - 180 Sec.
F	3 - 300 Sec.
G	0.1 - 10 Min.
H	0.3 - 30 Min.

Sockets & Accessories available

Build your Time Delay Relays with the [Online Product Builder](#)



Better. By Design.

800.238.7474

WWW.MACROMATIC.COM

SALES@MACROMATIC.COM



# PROGRAMMABLE | MULTI-RANGE TRUE OFF DELAY

## TR-6 SERIES TIME RANGER™

### APPLICATION DATA

#### Voltage Tolerance:

AC Operation: +10/-15% of nominal at 50/60 Hz  
DC Operation: +10/-15% of nominal

#### Load (Burden):

Maximum of 2 VA for all voltages. These products draw a brief inrush current on power-up of 1A to charge the internal circuitry.

#### Setting Accuracy:

Maximum Setting (Adjustable): +5%, -0%  
Minimum Setting (Adjustable): +0%, -50%

**Repeat Accuracy** (constant voltage and temperature):  
±50ms

**Reset Time:** 0.1 Seconds

#### Start-up Time:

(Time from when power is applied until unit is timing)  
0.05 Seconds

#### Maintain Function Time:

(Time unit continues to operate after power is removed)  
0.01 Seconds for all units

#### Temperature:

-28° to 65°C (-18° to 150°F)

#### Compatibility:

Using a solid state switch to initiate the time sequence is acceptable. See [www.macromatic.com/leakage](http://www.macromatic.com/leakage) or contact Macromatic for information regarding leakage current limits and other solid state design considerations.

#### Output Contacts:

DPDT 10A @ 240V AC; 8A @ 28V DC,  
1/2 HP @ 240V AC, 1/4HP @ 120V AC  
B300 & R300

#### Life:

Mechanical: 2,000,000 operations  
Full Load: 100,000 operations

**IMPORTANT:** These relays are shipped from the factory in the OFF state. A shock to the relay during shipping or installation may cause it to change to the ON state. It is recommended that control voltage be applied to the product for at least 0.1 second and removed to cycle the unit to the OFF state prior to use in the application. Please note that it will take as long as the OFF Delay setting to reset the unit once control voltage has been removed.

#### Approvals:

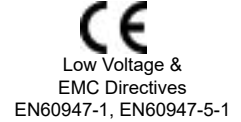

### DIMENSIONS

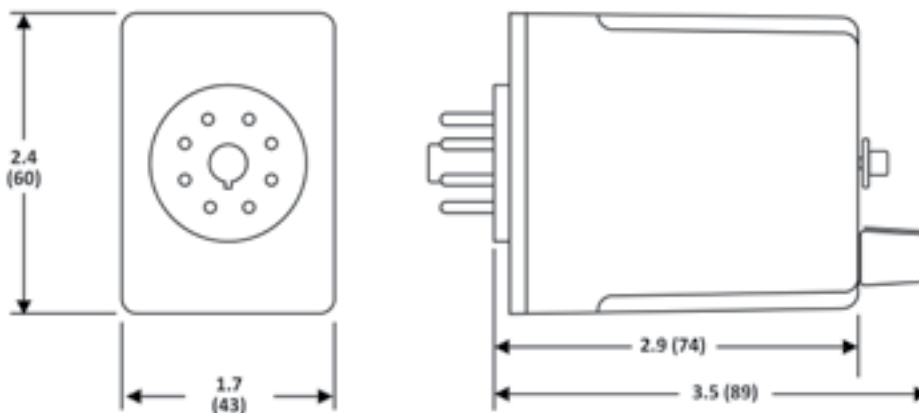

All Dimensions in  
Inches (Millimeters)

# PROGRAMMABLE | MULTI-RANGE

## DIGITAL-SET | TD-7 SERIES TIME RANGER™

The TD-781 Series offers an easy and accurate way to select a function and any time delay between 50ms and 999 hours. Programming is accomplished by using a pushbutton thumbwheel to select one of seven built-in time ranges and three pushbutton thumbwheels to digitally set the time delay required. This method provides a greater setting accuracy than is found on other units with an analog potentiometer. These units have a fifth pushbutton thumbwheel to select one of ten built-in functions. An LED indicates timing mode and time out condition.

Single-function versions available.



- ◆ Ten user-selectable modes in one unit
- ◆ Pushbutton Thumbwheels for digital set of time delay & function
- ◆ 50ms - 999 hour programmable time range
- ◆ Uses industry-standard 11 pin octal socket
- ◆ 10A DPDT output contacts
- ◆ LED indicates timing mode and time out conditions
- ◆ Pilot duty rating



Multi-Function Product			
FUNCTION ■	CONTROL VOLTAGE	CATALOG NUMBER	WIRING/ SOCKETS
<b>MULTI-FUNCTION</b> (10 Functions in One Unit)	120V AC/DC 12V DC	TD-78122 TD-78126	11 PIN OCTAL <b>70170-D</b>
<b>A</b> On Delay	24V AC/DC	TD-78128	
<b>B</b> Interval On	240V AC	TD-78121	<p><b>DIAGRAM 121</b></p>
<b>C</b> Off Delay *			
<b>D</b> Single Shot *			
<b>E</b> Flasher (OFF 1st)			
<b>F</b> Flasher (ON 1st)			
<b>G</b> On/Off Delay *			
<b>H</b> Single Shot Falling Edge *			
<b>J</b> Watchdog *			
<b>K</b> Triggered On Delay *			

■ See "Definitions of Timing Functions".

\* These are the only functions requiring use of the Control Switch shown in Wiring Diagrams above.

Sockets & Accessories available



Better. By Design.

**800.238.7474**

[WWW.MACROMATIC.COM](http://WWW.MACROMATIC.COM)

[SALES@MACROMATIC.COM](mailto:SALES@MACROMATIC.COM)

Build your Time Delay Relays with the [Online Product Builder](#)

# PROGRAMMABLE | MULTI-RANGE

## DIGITAL-SET | TD-7 SERIES TIME RANGER™



- ◆ Pushbutton Thumbwheels for digital set of time delay
- ◆ 50ms - 999 hour programmable time range
- ◆ Uses industry-standard 8 or 11 pin octal sockets
- ◆ 10A DPDT output contacts
- ◆ LED indicates timing mode and time out conditions
- ◆ Pilot duty rating



with appropriate socket

The TD-7 series of time delay relays offer an easy and accurate way to select any time delay between 50ms and 999 hours. Programming is accomplished by using a pushbutton thumbwheel to select one of seven built-in time ranges and three pushbutton thumbwheels to digitally set the time delay required. This method provides a greater setting accuracy than is found on other units with an analog potentiometer. An LED indicates timing mode and time out condition.

Multi-function versions available.

### Single Function Products

FUNCTION ■	CONTROL VOLTAGE	CATALOG NUMBER	WIRING/SOCKETS
<b>ON DELAY</b> <b>A</b>	120V AC/DC 12V DC 24V AC/DC 240V AC	TD-70222 TD-70226 TD-70228 TD-70221	8 PIN OCTAL <b>70169-D</b>  <b>DIAGRAM 1</b>
<b>INTERVAL ON</b> <b>B</b>	120V AC/DC 12V DC 24V AC/DC 240V AC	TD-70522 TD-70526 TD-70528 TD-70521	 <b>DIAGRAM 1</b>
<b>FLASHER</b> (OFF 1st) <b>E</b>	120V AC/DC 12V DC 24V AC/DC 240V AC	TD-70822 TD-70826 TD-70828 TD-70821	 <b>DIAGRAM 1</b>
<b>OFF DELAY</b> <b>C</b>	120V AC/DC 12V DC 24V AC/DC 240V AC	TD-71622 TD-71626 TD-71628 TD-71621	11 PIN OCTAL <b>70170-D</b>  <b>DIAGRAM 2</b>
<b>SINGLE SHOT</b> <b>D</b>	120V AC/DC 12V DC 24V AC/DC 240V AC	TD-71522 TD-71526 TD-71528 TD-71521	 <b>DIAGRAM 2</b>

■ See "Definitions of Timing Functions".

Sockets & Accessories available



Better. By Design.

**800.238.7474**

[WWW.MACROMATIC.COM](http://WWW.MACROMATIC.COM)

[SALES@MACROMATIC.COM](mailto:SALES@MACROMATIC.COM)

Build your Time Delay Relays with the [Online Product Builder](#)

# TD-7 SERIES TIME RANGER™

## APPLICATION DATA

### Voltage Tolerance:

AC Operation: +10/-15% of nominal at 50/60 Hz.  
DC Operation: +10/-15% of nominal.

### Load (Burden):

3 VA

### Setting Accuracy:

**Constant Voltage & Temperature w/i specifications:**  
±0.1% of set time or ±50ms, whichever is greater

**For Variable Voltage & Temperature w/i specifications:**  
±1% of set time or ±50ms, whichever is greater

### Repeat Accuracy:

**Constant Voltage & Temperature w/i specifications:**  
±0.1% of set time or ±0.02 seconds, whichever is greater

**For Variable Voltage & Temperature w/i specifications:**  
±1% of set time or ±0.02 seconds, whichever is greater

### Reset Time:

On Delay/Interval/Flasher: 0.1 Seconds  
Functions with Control Switches: 0.04 Seconds

### Start-up Time:

(Time from when power is applied until unit is timing)  
0.05 Seconds for all units

### Maintain Function Time:

(Time unit continues to operate after power is removed)  
0.01 Seconds for all units

**Temperature:** Operating: -28° to 65°C (-18° to 149°F)  
Storage: -40° to 85°C (-40° to 185°F)

**Insulation Voltage:** 2,000 volts

### Output Contacts:

DPDT 10A @ 240V AC/30V DC,  
1/2HP @ 120/240V AC (N.O.), 1/3HP @ 120/240V AC (N.C.)  
B300 & R300; AC15 & DC13

### Life:

Mechanical: 10,000,000 operations  
Full Load: 100,000 operations

### Compatibility:

Using a solid state switch to initiate the time sequence is acceptable. See [www.macromatic.com/leakage](http://www.macromatic.com/leakage) or contact Macromatic for information regarding leakage current limits and other solid state design considerations.

### Initiating Units with Control Switch Triggers:

Timing sequence must be initiated only after control voltage is applied to unit. Minimum required trigger switch closure time is 0.1 seconds.

### LED:

Red LED. Refer to instruction sheet provided with product to determine code for relay & timing status.

### Approvals:



File #E109466



File #LR45565



Low Voltage &  
EMC Directives  
EN60947-1, EN60947-5-1



with  
appropriate  
socket  
File #E109466

## DIMENSIONS

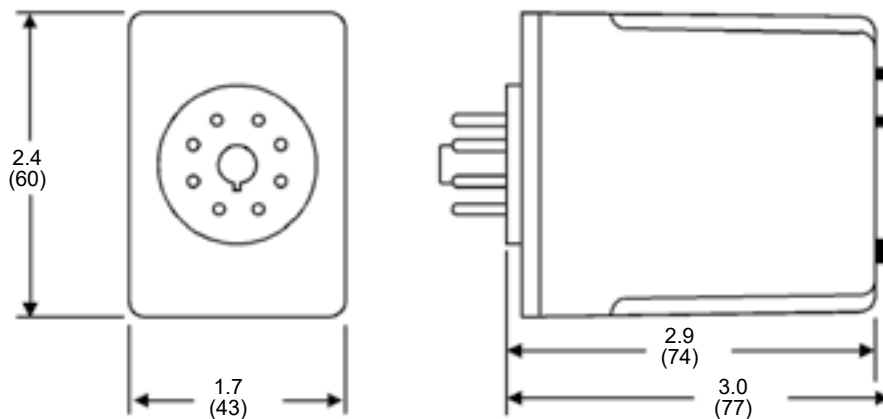

All Dimensions in  
Inches (Millimeters)

# PROGRAMMABLE | MULTI-FUNCTION

## DIP-SWITCH | DIGITAL-SET | TD-8 SERIES



- ◆ Sixteen user-selectable modes in one unit
- ◆ DIP-Switches for accurate digital set of time delay & selection of function
- ◆ 50ms - 10,230 hours programmable time delay (Single Mode functions only)
- ◆ Uses industry-standard 8 or 11 pin octal socket
- ◆ Pilot duty rating



with appropriate socket



Better. By Design.

**800.238.7474**

[WWW.MACROMATIC.COM](http://WWW.MACROMATIC.COM)

[SALES@MACROMATIC.COM](mailto:SALES@MACROMATIC.COM)

The TD-881 Series offers the digital-set accuracy of DIP-switch setting as well as the flexible programmability of a multi-function and multi-time range relay. These products provide an easy and accurate method to select any of 16 time delay functions and any time delay between 50ms and 10,230 hours (310 hours maximum for Dual Mode functions). Programming is accomplished through the use of two 10-position DIP-switches. This product can literally replace hundreds of different catalog numbers, thereby reducing inventory requirements.



### MULTI-FUNCTION ■ (16 Functions in One Unit)

#### Single Mode

- ◆ On Delay
- ◆ Interval On
- ◆ Flasher (OFF 1st)
- ◆ Flasher (ON 1st)
- ◆ Off Delay \*
- ◆ Single Shot \*
- ◆ Watchdog \*
- ◆ Single Shot (Trailing Edge) \*
- ◆ Triggered On Delay \*

#### Dual Mode

- ◆ Repeat Cycle (OFF 1st)
- ◆ Repeat Cycle (ON 1st)
- ◆ Delayed Interval
- ◆ Triggered Delayed Interval \*
- ◆ On/Off Delay \*
- ◆ Single Shot-Flasher \*
- ◆ On Delay/Flasher

\* These are the only functions requiring use of the Control Switch shown in Wiring Diagrams below.

OUTPUT	CONTROL VOLTAGE	CATALOG NUMBER	WIRING/SOCKETS
<b>11 Pin DPDT</b>	120V AC/DC 12V DC 24V AC/DC 240V AC	TD-88122 TD-88126 TD-88128 TD-88121	11 PIN OCTAL <b>70170-D</b>  <b>DIAGRAM 121</b>
<b>8 Pin SPDT</b>	120V AC/DC 12V DC 24V AC/DC 240V AC	TD-88162 TD-88166 TD-88168 TD-88161	8 PIN OCTAL <b>70169-D</b>  <b>DIAGRAM 169</b>

■ See "Definitions of Timing Functions".

Sockets & Accessories available

Build your Time Delay Relays with the [Online Product Builder](#)

# PROGRAMMABLE | SINGLE FUNCTION

## DIP-SWITCH | DIGITAL-SET | TD-8 SERIES

The TD-8 Series time delay relays offer an easy and accurate method to select any time delay between 100ms and 1,023 hours. Programming is accomplished through the use of a 10-position DIP-switch. Each position is marked with a binary time increment. The required delay is selected by moving the switch of each increment to the ON position and adding their corresponding values (see examples below). This method provides a greater setting accuracy than is found on other units with an analog potentiometer. An LED indicates relay status.

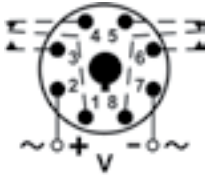
FUNCTION ■	CONTROL VOLTAGE 50/60Hz.	CATALOG NUMBER **	WIRING/SOCKETS
<b>ON DELAY</b> A	120V AC/DC 12V DC 24V AC/DC 240V AC	TD-80222-** TD-80226-** TD-80228-** TD-80221-**	8 PIN OCTAL 70169-D 
<b>INTERVAL ON</b> B	120V AC/DC 12V DC 24V AC/DC 240V AC	TD-80522-** TD-80526-** TD-80528-** TD-80521-**	DIAGRAM 1
<b>REPEAT CYCLE *</b> (OFF Time First Followed By ON Time and Repeating) L	120V AC/DC 12V DC 24V AC/DC 240V AC	TD-83122-** TD-83126-** TD-83128-** TD-83121-**	
<b>REPEAT CYCLE *</b> (ON Time First Followed By OFF Time and Repeating) M	120V AC/DC 12V DC 24V AC/DC 240V AC	TD-85122-** TD-85126-** TD-85128-** TD-85121-**	DIAGRAM 2
<b>OFF DELAY</b> Control Switch Trigger C	120V AC/DC 12V DC 24V AC/DC 240V AC	TD-81622-** TD-81626-** TD-81628-** TD-81621-**	
<b>SINGLE SHOT</b> Control Switch Trigger D	120V AC/DC 12V DC 24V AC/DC 240V AC	TD-81522-** TD-81526-** TD-81528-** TD-81521-**	

■ See "Definitions of Timing Functions".

\* ON & OFF Time Ranges for these functions are the same. See [www.macromatic.com/onoff](http://www.macromatic.com/onoff) for information on how to order a unit with different ON & OFF time ranges.

### TIME DELAYS

**TIMING RANGE TABLE	
COMPLETE PRODUCT NUMBER USING TWO DIGIT CODE BELOW: i.e., TD-80222-40	
Time Delay Range	Code
0.1 - 102.3 Sec.	40
1 - 1,023 Sec.	41
10 - 10,230 Sec.	42
1 - 1,023 Min.	43
10 - 10,230 Min.	44
1 - 1,023 Hr.	45

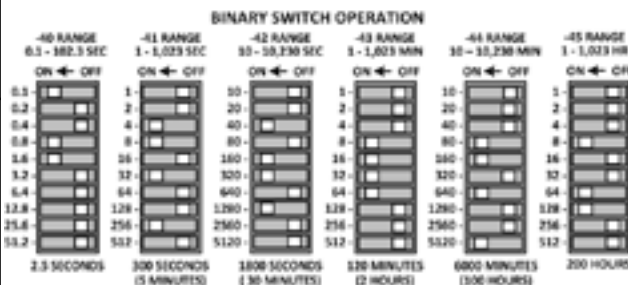

Sockets & Accessories available

Build your Time Delay Relays with the [Online Product Builder](#)



Single Mode

Dual Mode

- ◆ DIP-Switches for accurate digital set of time delay
- ◆ 100ms - 1,023 hours programmable time delay
- ◆ Uses industry-standard 8 or 11 pin octal sockets
- ◆ 10A DPDT output contacts
- ◆ LED indicates relay status
- ◆ Pilot duty rating



with appropriate socket



Better. By Design.

800.238.7474

WWW.MACROMATIC.COM

SALES@MACROMATIC.COM

# TD-8 SERIES

## DIP-SWITCH | DIGITAL-SET

### PROGRAMMING FUNCTION & TIME DELAY

(TD-881 Series Multi-Function Only)

Programming is accomplished through the use of two 10-position DIP-switches. Switches A-D of the left-mounted DIP-switch are used to select a function (see the descriptions of how each function operates in "Definition of Timing Functions" in this catalog). Switches E, F & G of the same DIP-switch are used to select the time base (t) for single mode functions and (t1) for dual mode functions. Switches H, J & K are used to select the time base (t2) for dual mode functions. A convenient chart is on the side of the product to clearly illustrate how to set both the function and time base.

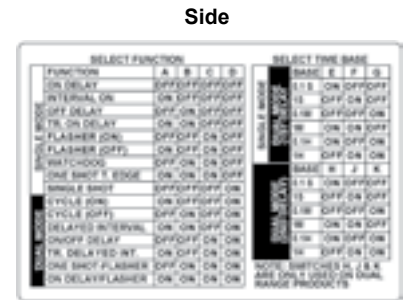
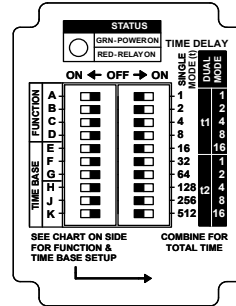

The right-mounted 10-position DIP-switch is used to select the time delay within the time base or bases selected with switches E-K from the first DIP-switch. Each position on the right-mounted DIP-switch is marked with a time increment. The required delay, (t) for single mode functions or (t1) and (t2) for dual mode functions, is selected by moving the switch of each increment to the ON position and adding their corresponding values. NOTE: Dual mode functions can either have the same or different (t1) and (t2) times as well as different time bases. NOTE: Switches H, J, & K are only used on dual mode functions and are not used for single mode functions.

LED Indicator: **Green ON--Power, Red ON--Relay Energized**

For more information, see [www.macromatic.com/onoff](http://www.macromatic.com/onoff).

### APPLICATION DATA

#### Voltage Tolerance:

AC Operation: +10/-15% of nominal at 50/60 Hz.  
DC Operation: +10/-15% of nominal.

Load (Burden): 2 VA

#### Setting Accuracy:

**Constant Voltage & Temperature w/i specifications:**  
±0.1% of set time or ±50ms, whichever is greater  
**For Variable Voltage & Temperature w/i specifications:**  
±1% of set time or ±50ms, whichever is greater

#### Repeat Accuracy:

**Constant Voltage & Temperature w/i specifications:**  
±0.1% of set time or ±0.02 seconds, whichever is greater  
**For Variable Voltage & Temperature w/i specifications:**  
±1% of set time or ±0.02 seconds, whichever is greater

#### Reset Time:

All Functions Triggered by a Control Switch: 0.04 Seconds  
All Other Functions: 0.1 Seconds

#### Start-up Time:

(Time from when power is applied until unit is timing)  
0.05 Seconds for all units

#### Maintain Function Time:

(Time unit continues to operate after power is removed)  
0.01 Seconds for all units

**Insulation Voltage:** 2,000 volts

**Temperature:** Operating: -28° to 65°C (-18° to 149°F)  
Storage: -40° to 85°C (-40° to 185°F)

#### Output Contacts:

DPDT 10A @ 240V AC/30V DC,  
1/2HP @ 120/240V AC (N.O.), 1/3HP @ 120V AC (N.C.)  
B300 & R300; AC15 & DC13

#### Life:

Mechanical: 10,000,000 operations  
Full Load: 100,000 operations

#### Compatibility:

Using a solid state switch to initiate the time sequence is acceptable. See [www.macromatic.com/leakage](http://www.macromatic.com/leakage) or contact Macromatic for information regarding leakage current limits and other solid state design considerations.

#### Control Switch Triggered Units:

Minimum required trigger switch closure time is 0.05 seconds.

#### Approvals:



File #E109466



File #LR45565



Low Voltage &  
EMC Directives  
EN60947-1, EN60947-5-1



with  
appropriate  
socket  
File #E109466

### DIMENSIONS

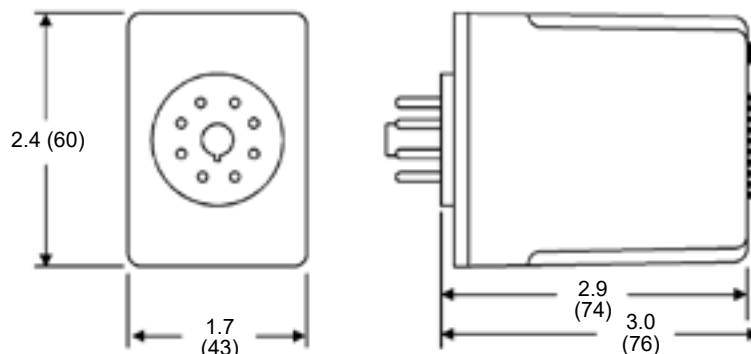

All Dimensions in  
Inches (Millimeters)

# MULTI-FUNCTION | MULTI-RANGE

## DIGITAL-SET | TAD SERIES



- ◆ Push-button thumbwheels for digital-setting of time delay & selection of function
- ◆ 10 field-selectable functions in one unit
- ◆ 10ms to 9,990 Hours programmable timing range
- ◆ Universal 24-240V AC/DC control voltage
- ◆ LCD display
- ◆ Panel, track or surface mounting
- ◆ 1/16 DIN style case (comes with panel-mounting adapter)
- ◆ 5A SPDT output contacts

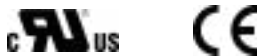

Better. By Design.

**800.238.7474**  
**WWW.MACROMATIC.COM**  
**SALES@MACROMATIC.COM**

MULTI-FUNCTION	CONTROL VOLTAGE	CATALOG NUMBER	WIRING/SOCKETS ■
<b>10 FIELD-SELECTABLE FUNCTIONS●</b>	24-240V AC 50/60Hz & 24-240V DC  8 Pin Octal	TAD1U	<b>SEE DIAGRAMS NEXT PAGE</b>

- Functions Include: On Delay (2 Versions), Interval, Flicker [Flasher] (2 Versions), One Shot Out Flicker [Delayed Interval/Pulse], Off Delay, On/Off Delay, Interval Delay [Single Shot] & Integration Time [Accumulative On Delay] See "Definitions of Timing Functions".
- See below for **Sockets & Accessories**.

### APPLICATION DATA

**Voltage Tolerance:**

±10% of rated voltage

**Load (Burden):**

Less than 2.5 VA

**Repeat Accuracy:**

±0.01%, ±0.05 seconds (includes variation due to voltage and temperature changes)

**Recycle Time:**

0.2 seconds maximum

**Temperature:**

Operating: -10° to 55°C (14° to 131°F)  
 Storage: -40° to 85°C (-40° to 185°F)

**LCD Display:** Shows time remaining in both digit & bar graph form—also shows relay status & time base. In addition, a switch on the bottom of the unit allows choice of timing up or timing down display.

**Output Contacts:**

5A SPDT Resistive @ 250V AC

**Life:**

Mechanical: 10,000,000 operations  
 Full Load: 100,000 operations

**Approvals:**



### SOCKETS & ACCESSORIES

DESCRIPTION	PRODUCT NUMBER
8 Pin Octal Socket	70169-D❖
8 Pin Octal Socket (Back Mounting)	SR6P-M08G
Panel-Mounting Adaptor	Included

❖ For Surface or Track Mounting—See Sockets & Accessories for additional information



SR6P-M08G

### DIMENSIONS

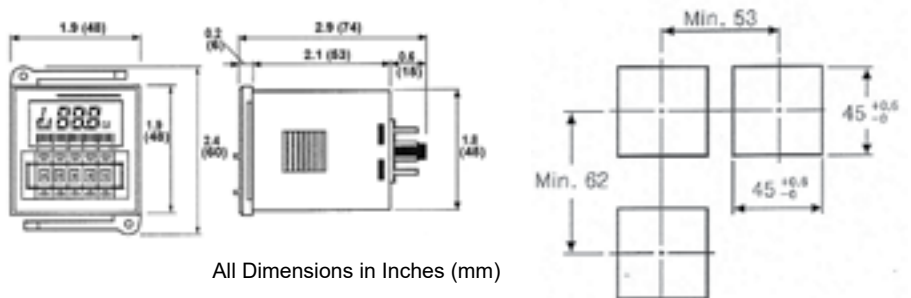

All Dimensions in Inches (mm)

PANEL CUTOUT

**800.238.7474 | WWW.MACROMATIC.COM | SALES@MACROMATIC.COM**



# DEFINITION OF TIMING FUNCTIONS

## DIGITAL-SET | TAD SERIES

### Functions for TAD1U

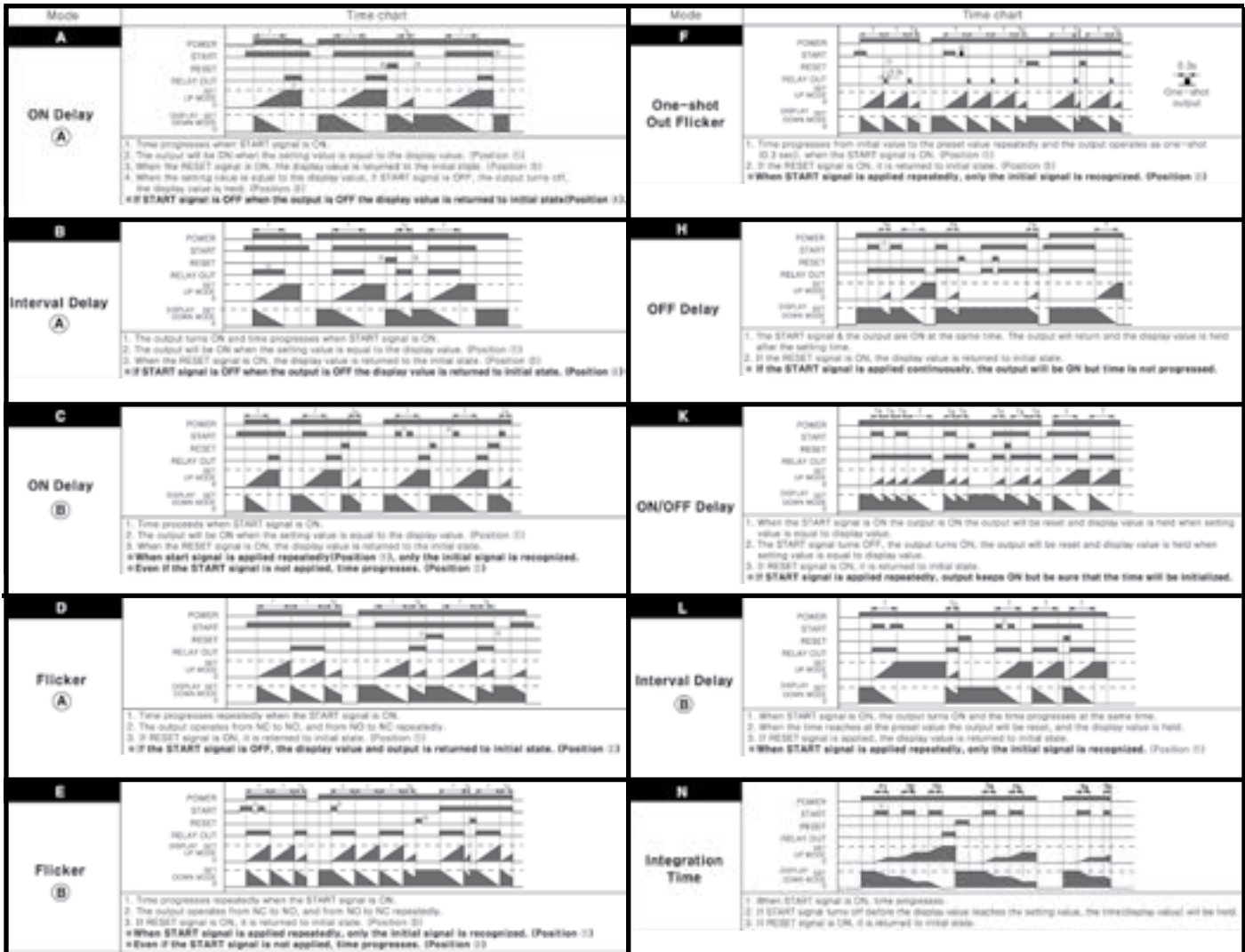

NOTE: Timing is paused when the INHIBIT signal is ON during a timing cycle and resumes when it is OFF.

#### TAD1U All Functions

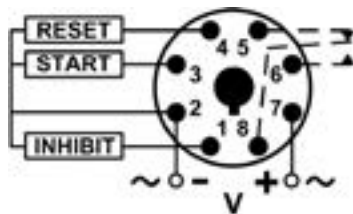

DIAGRAM 171

# MULTI-FUNCTION | MULTI-RANGE

## ANALOG-SET | TAA SERIES



- ◆ 6 field-selectable functions in one unit
- ◆ Large dial for setting of time delay
- ◆ 50ms to 100 Hours programmable timing range
- ◆ Universal 100-240V AC/ 24-240V DC control voltage
- ◆ Panel, track or surface mounting
- ◆ 1/16 DIN style case (comes with panel-mounting adaptor)

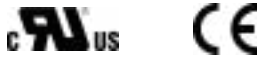

Better. By Design.

**800.238.7474**  
**WWW.MACROMATIC.COM**  
**SALES@MACROMATIC.COM**

MULTI-FUNCTION ◆	CONTROL VOLTAGE	CATALOG NUMBER	WIRING/SOCKETS ■
Includes Six (6) Functions Built-in (See "Definitions of Timing Functions".)	100-240V AC 50/60Hz & 24-240V DC	TAA1U	<b>SEE DIAGRAMS NEXT PAGE</b> 8 Pin Octal
Includes Six (6) Functions Built-in (See "Definitions of Timing Functions".)	100-240V AC 50/60Hz & 24-240V DC	TAA2U	<b>SEE DIAGRAMS NEXT PAGE</b> 11 Pin Octal

- ◆ See "Definitions of Timing Functions".
- See below for Sockets & Accessories.

### APPLICATION DATA

#### Voltage Tolerance:

±10% of rated voltage.

#### Load (Burden):

Less than 2.5 VA

#### Repeat Accuracy:

±0.01%, ±0.05 seconds (includes variation due to voltage and temperature changes).

#### Recycle Time:

0.2 seconds maximum.

#### Temperature:

Operating: -10° to 55°C (14° to 131°F)  
 Storage: -40° to 85°C (-40° to 185°F)

#### LED Indicators:

One red LED indicates Control voltage / Timing (flashing) & a second red LED indicates relay status.

#### Output Contacts:

5A DPDT Resistive @ 250V AC

#### Enclosure Protection Rating:

IP40 (front face)

#### Life:

Mechanical: 10,000,000 operations  
 Full Load: 100,000 operations

#### Approvals:



### SOCKETS & ACCESSORIES

DESCRIPTION	PRODUCT NUMBER
8 Pin Octal Socket	70169-D❖
8 Pin Octal Socket (Back Mounting)	SR6P-M08G
11 Pin Octal Socket	70170-D❖
11 Pin Octal Socket (Back Mounting)	SR6P-M11G
Panel-Mounting Adaptor	Included

❖ For Surface or Track Mounting - See Sockets & Accessories for additional information



SR6P-M08G



SR6P-M11G

### DIMENSIONS

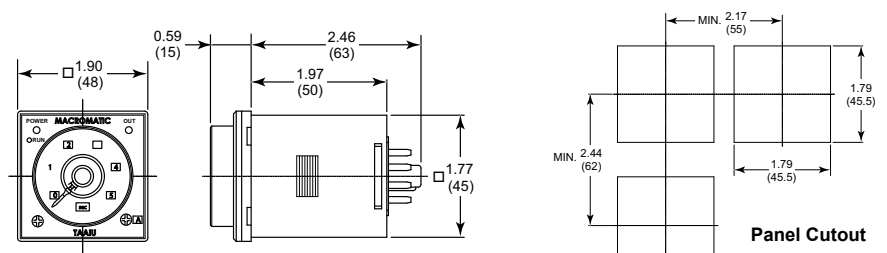

All Dimensions in Inches (mm)

# DEFINITION OF TIMING FUNCTIONS

## ANALOG-SET | TAA SERIES

### Functions for TAA1U

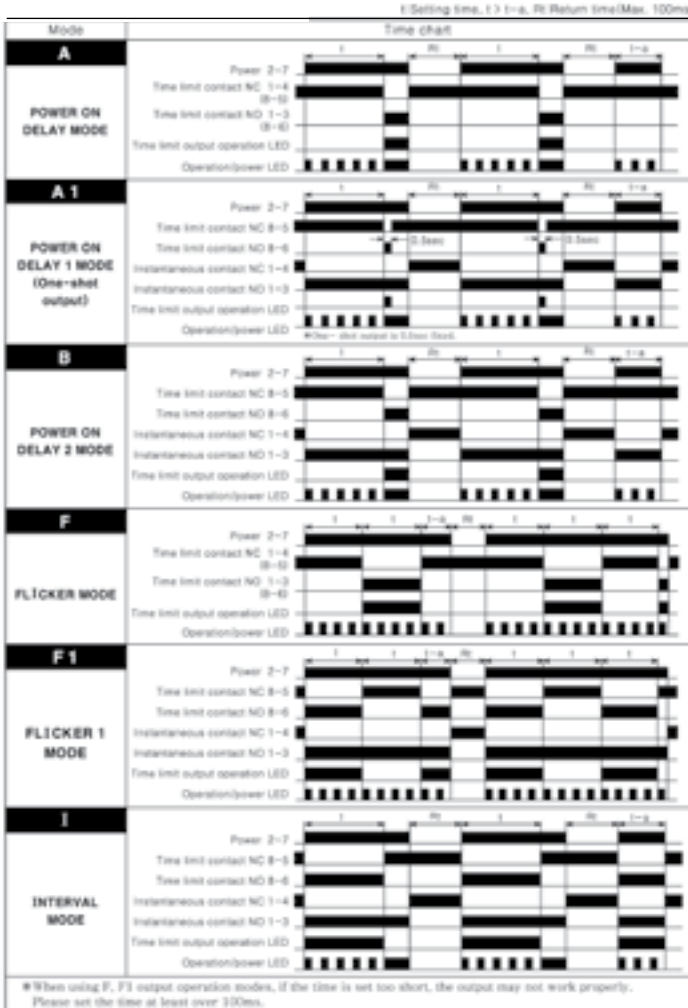

### Functions for TAA2U

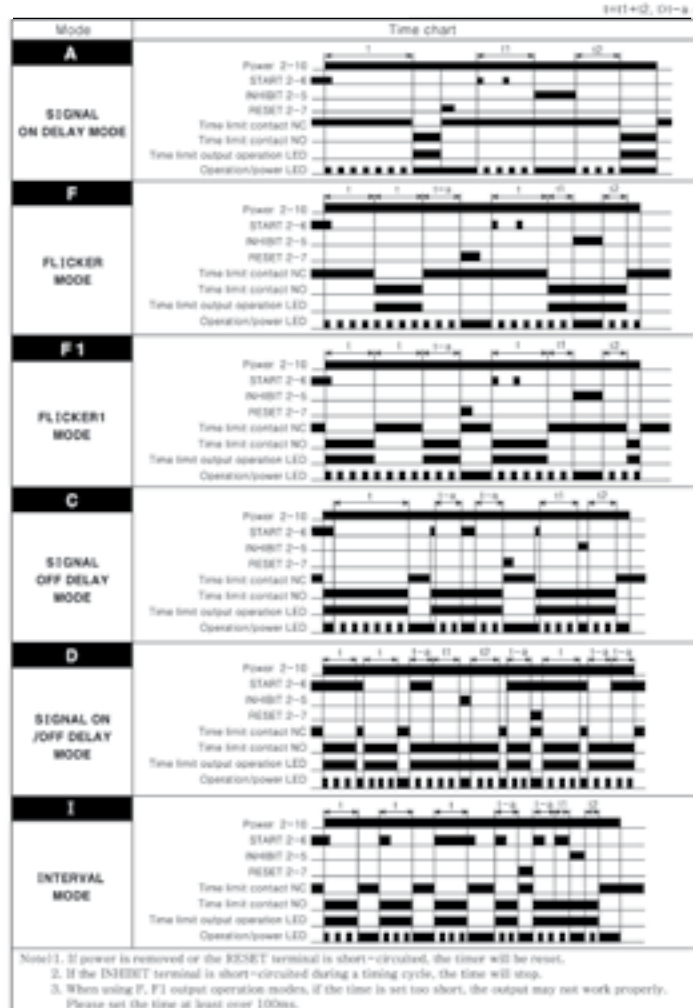

TAA1U Functions A, F

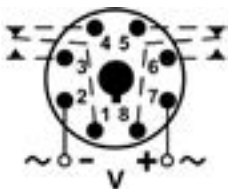

DIAGRAM 134

TAA1U Functions A1, B, F1 & I

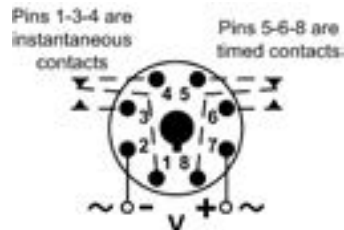

DIAGRAM 182

TAA2U All Functions

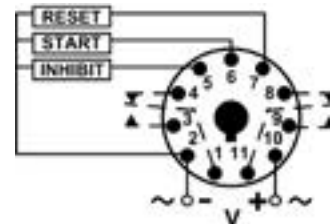

DIAGRAM 183

# PROGRAMMABLE MULTI-FUNCTION | MULTI-RANGE

## TE-881 SERIES



- ◆ 10 field-selectable functions in one unit
- ◆ Universal Control voltage : 12-240V AC/DC
- ◆ 0.1 second - 10 days programmable time delay
- ◆ 15A SPDT output contacts
- ◆ LEDs indicate output relay status & timing mode
- ◆ Compact 17.5mm enclosure mounts on 35mm DIN track
- ◆ Pilot duty rating



Better. By Design.

**800.238.7474**

[WWW.MACROMATIC.COM](http://WWW.MACROMATIC.COM)

[SALES@MACROMATIC.COM](mailto:SALES@MACROMATIC.COM)

The TE-881 Series time delay relays offer 10 timing functions and a universal voltage input (12-240V AC/DC) with a programmable time range from 0.1 second – 10 days all in one compact unit. Choose between versions with 15A SPDT or DPDT output contacts. A green LED indicates control voltage applied; a red LED blinks during timing and is steady when the output relay is energized. These products have a compact 17.5mm enclosure which snaps on to 35mm DIN rail. This conserves space and reduces installation time, which saves money. With all this flexibility, the TE-881 Series replaces hundreds of separate time delay relays.

CATALOG NUMBER	TE-8816U	TE-8812U
<b>Input</b>		
<b>Voltage Range</b>	12-240V AC/DC, 50/60Hz	12-240V AC/DC, 50/60Hz
<b>Operating Range</b>	-15% of 12V, +10% of 240V	-15% of 12V, +10% of 240V
<b>Burden</b>	3VA (AC), 1.7W (DC)	3VA (AC), 1.7W (DC)
<b>Output</b>		
<b>Configuration</b>	SPDT	DPDT
<b>Rating</b>	15A @ 240V AC 1/3HP @ 120V AC, 3/4HP @ 240V AC, B300	
<b>Minimum Switching</b>	100mA @ 5V AC or 5V DC	
<b>Contact Material</b>	Silver Alloy	
<b>Life</b>	10 million operations mechanical; 70,000 electrical	
<b>Timing</b>		
<b>Number of Functions</b>	10 (see descriptions on Page 44)	
<b>Time Ranges</b>	8 different time ranges built-in:	
	100 ms - 1 Sec.	0.1 - 1 Hr.
	1 - 10 Sec.	1 - 10 Hr.
	0.1 - 1 Min.	0.1 - 1 Day
	1 - 10 Min.	1 - 10 Days
<b>Repeat Accuracy</b>	±0.2%	
<b>Setting Accuracy</b>	5%	
<b>Reset Time</b>	150ms maximum	
<b>Trigger Pulse Length</b>	50ms maximum	
<b>Other</b>		
<b>Mounting</b>	35mm DIN Rail only	
<b>Agency Approval</b>	UL US CE (File #E109466)	
<b>Temperature</b>	Storage: -30° to 70° C (-22° to 158° F) Operating: -20° to 55° C (-4° to 131° F)	
<b>LED Indication</b>	Green-Control voltage ; Red-Timing or Relay ON	
<b>Terminations</b>	14 AWG (2.5mm <sup>2</sup> )	

# PROGRAMMABLE MULTI-FUNCTION | MULTI-RANGE

## TE-881 SERIES

### FUNCTIONS

FUNCTION	DIAL SETTING	GRAPH	FUNCTION	DIAL SETTING	GRAPH
ON DELAY	<b>A</b>		REPEAT CYCLE * (ON 1ST)	<b>F</b>	
REPEAT CYCLE * (OFF 1ST)	<b>B</b>		PULSE GENERATOR (PULSE=0.5 SEC)	<b>G</b>	
INTERVAL	<b>C</b>		ONE SHOT	<b>H</b>	
OFF DELAY	<b>D</b>		ON/OFF DELAY *	<b>I</b>	
RETRIGGERABLE ONE SHOT (Watchdog)	<b>E</b>		MEMORY LATCH (Latching Relay)	<b>J</b>	

\* Note: ON & OFF times are the same.

### CONNECTION DIAGRAMS



TE-8816U  
SPDT



TE-8812U  
DPDT

### DIMENSIONS

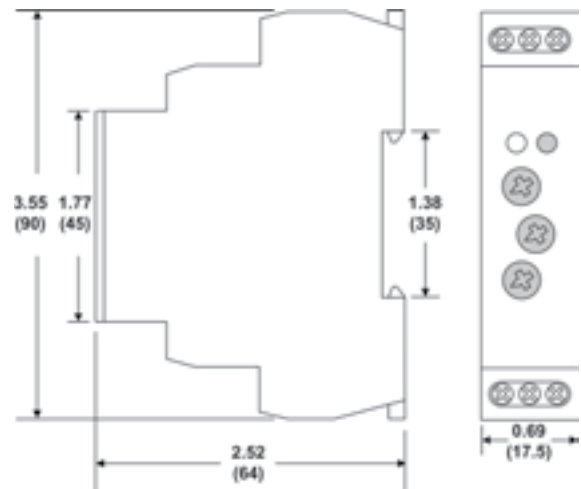

All Dimensions in  
Inches (Millimeters)

# PROGRAMMABLE SINGLE-FUNCTION | MULTI-RANGE

## TE-6 SERIES



- ◆ Single function time delay
- ◆ Universal Control voltage : 12-240V AC/DC
- ◆ 0.1 second - 100 hours time delay ranges
- ◆ 10A SPDT output contacts
- ◆ LEDs indicate output relay status & timing mode
- ◆ Compact 17.5mm enclosure mounts on 35mm DIN-rail



Better. By Design.

**800.238.7474**

**WWW.MACROMATIC.COM**

**SALES@MACROMATIC.COM**

Single function TE-6 Series Series Time Delay Relays are used for applications where timing function does not change. All functions initiated by the control voltage can use the control input to inhibit the ongoing delay.

These relays offer ten timing ranges with a universal voltage input (12 -240V AC/ DC). Red and green LED provides clear indication of relay status.

The compact 17.5 mm enclosure mounts on 35 mm DIN-rail.

CATALOG NUMBERS	TE-6026U	TE-6166U
FUNCTION	ON DELAY	OFF DELAY
<b>CONTROL VOLTAGE</b>		
Voltage Range	12-240V AC/DC, 50/60Hz	
Operating Range	-15% of 12V, +10% of 240V (-15%, +10%)	
<b>OUTPUT</b>		
Configuration	SPDT	
Rating	10A @ 250V AC	
Minimum Switching	100mA @ 5V	
Contact Material	Silver Alloy	
Life	10 million operations mechanical; 50,000 electrical	
<b>TIMING</b>		
Time Ranges	Ten Ranges: 0.1 Sec. - 100 Hr.	
Repeat Accuracy	±0.2%	
Setting Accuracy	5%	
Reset Time	150ms maximum	
Trigger Pulse Length	50ms minimum	
<b>OTHER</b>		
Mounting	35mm DIN Rail only	
Agency Approval		
Temperature	Storage: -30° to 70° C (-22° to 158° F) Operating: -20° to 55° C (-4° to 131° F)	
LED Indication	Green - Control Voltage; Red - Timing or Relay ON	
Terminations	Solid or stranded wire, 12-22 AWG	
Weight	61 g (0.13 lb)	

# PROGRAMMABLE SINGLE-FUNCTION | MULTI-RANGE

## TE-6 SERIES

### FUNCTIONS

FUNCTION	DESCRIPTION	GRAPH
<b>ON DELAY (TE-6026U)</b>	Upon application of control voltage, the time delay (t) begins. At the end of the time delay (t), the output is energized. Control voltage must be removed to reset the time delay relay and de-energize the output.	
<b>ON DELAY WITH INHIBIT (TE-6026U)</b>	Upon application of control voltage, the time delay (t) begins. At the end of the time delay (t), the output is energized. Control voltage must be removed to reset the time delay relay and de-energize the output. If the control contact (S) is closed during the time delay, the timing is paused and continues only after the control contact(S) reopens.	
<b>OFF DELAY (TE-6166U)</b>	Upon application of control voltage, the time delay relay is ready to accept a trigger. When the trigger is applied, the output is energized. Upon removal of the trigger, the time delay (t) begins. At the end of the time delay (t), the output is de-energized. Any application of the trigger during the time delay will reset the time delay (t) and the output remains energized.	

<b>LED STATUS INDICATION (RED)</b>		
------------------------------------	--	--

### WIRING

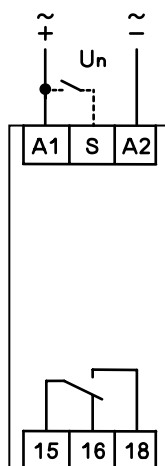

### DIMENSIONS

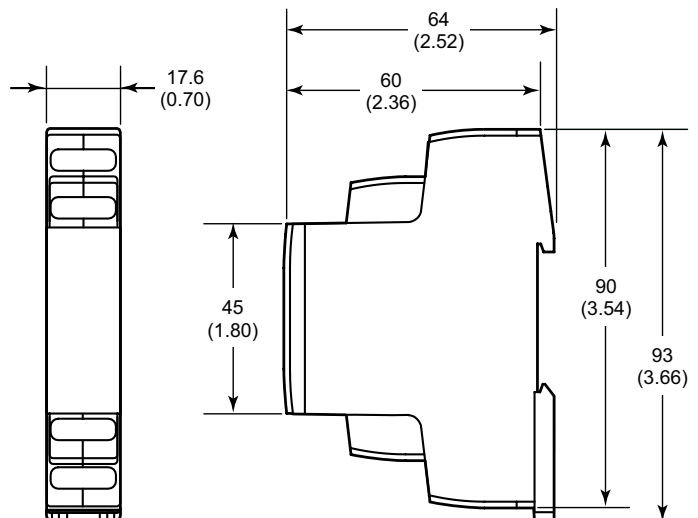

All Dimensions in Inches (Millimeters)

# SOCKETS & ACCESSORIES

## 8 Pin Octal Socket- Surface or DIN Rail-Mounted

- ◆ 10A @ 600V
- ◆ 1 or 2 #12-20 AWG Wire
- ◆ Pressure Wire Clamp Terminations
- ◆ Recommended Tightening Torque 12 in-lbs



File #E169693 File #LR701114



Catalog Number:  
70169-D

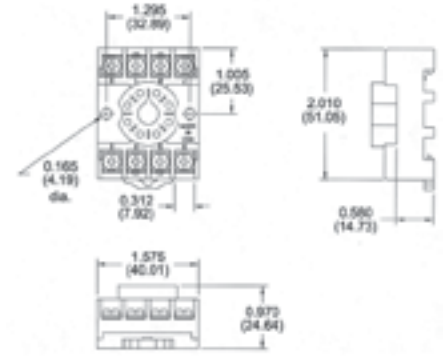
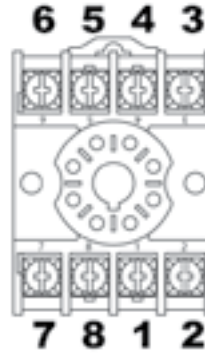

## 11 Pin Octal Socket Surface or DIN Rail-Mounted

- ◆ 10A @ 300V
- ◆ 1 or 2 #12-20 AWG Wire
- ◆ Pressure Wire Clamp Terminations
- ◆ Recommended Tightening Torque 12 in-lbs



File #E169693 File #LR701114



Catalog Number:  
70170-D

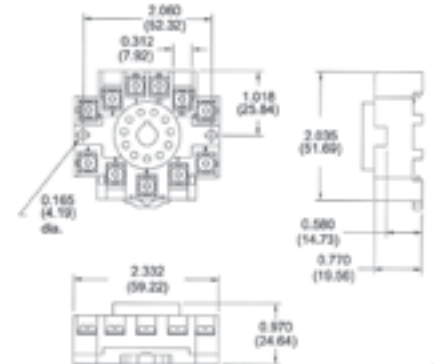
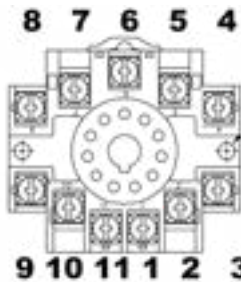

## 8 Pin Octal Socket Back-Mounted

- ◆ 10A @ 300V
- ◆ Pressure Wire Clamp Terminations
- ◆ Recommended Tightening Torque 7 in-lbs



File #E60008



Catalog Number:  
SR6P-M08G

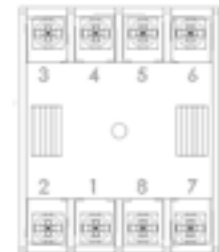

## 11 Pin Octal Socket Back-Mounted

- ◆ 10A @ 300V
- ◆ Pressure Wire Clamp Terminations
- ◆ Recommended Tightening Torque 7 in-lbs



File #E60008



Catalog Number:  
SR6P-M11G

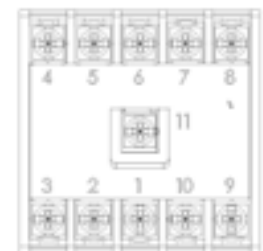



# SOCKETS & ACCESSORIES

## Hold Down Spring Catalog Number 70166

Can be used for:

- ◆ Panel-Mounted Sockets
- ◆ Sockets Mounted to 35mm DIN Rail \*

\* Requires two #8, 3/4" length machine screws with washers & nuts--contact Macromatic or [www.macromatic.com/70166](http://www.macromatic.com/70166) for more information.



## DIN Rail Adaptor Kit Catalog Number 70500

Quick & Economical Way to Install Any THx Series 2" x 2" Encapsulated Time Delay Relays on 35mm DIN Rail

- ◆ Clip Comes with a Threaded Hole to Eliminate Need for a Washer & Nut
- ◆ All Mounting Hardware Included
- ◆ Recommended Tightening Torque of 8 in-lbs.



# DEFINITION OF TIMING FUNCTIONS

Understanding the differences between all the functions available in time delay relays can sometimes be a daunting task. To begin with, time delay relays are simply control relays with a time delay built in. Their purpose is to control an event based on time.

Typically, time delay relays are initiated or triggered by one of two methods, depending on the function:

- ◆ application of control voltage
- ◆ application of a trigger

These triggers can be one of two signals: a control switch (dry contact), i.e., limit switch, push button, float switch, etc., or voltage (commonly known as a power trigger).

**CAUTION: any time delay relay that is designed to be initiated with a dry contact control switch trigger could be damaged if voltage is applied to the trigger switch terminals. Only products that have a “power trigger” should be used with voltage as the trigger.**

To help understand, some definitions are important:

- ◆ Control voltage - control voltage applied to the input terminals. Depending on the function, control voltage will either initiate the unit or make it ready to initiate when a trigger is applied.
- ◆ Trigger- on certain timing functions, a trigger is used to initiate the unit after control voltage has been applied. As noted above, this trigger can either be a control switch (dry contact switch) or a power trigger (voltage).
- ◆ Output (Load) - every time delay relay has an output (either mechanical relay or solid state) that will open & close to control the load. Note that the user must provide the voltage to power the load being switched by the output contacts of the time delay relay. In all wiring diagrams, the output is shown in the normal de-energized position.

Below and on the following pages are both written and visual descriptions on how the common timing functions operate. A Timing Chart shows the relationship between Control voltage, Trigger (if present) and Output. If you cannot find a product to fit your requirements or have any questions, Macromatic’s Application Engineers offer technical information along with product selection and application assistance. Call us at 800-238-7474 or e-mail us [tech-help@macromatic.com](mailto:tech-help@macromatic.com).

Function/Code	Operation	Timing Chart
<b>ON DELAY</b> Delay on Operate Delay on Make <b>A</b>	Upon application of control voltage, the time delay (t) begins. At the end of the time delay (t), the output is energized. Control voltage must be removed to reset the time delay relay & de-energize the output..	
<b>INTERVAL ON</b> Interval <b>B</b>	Upon application of control voltage, the output is energized and the time delay (t) begins. At the end of the time delay (t), the output is de-energized. Control voltage must be removed to reset the time delay relay.	
<b>OFF DELAY</b> Delay on Release Delay on Break Delay on De-Energization <b>C</b>	Upon application of control voltage, the time delay relay is ready to accept a trigger. When the trigger is applied, the output is energized. Upon removal of the trigger, the time delay (t) begins. At the end of the time delay (t), the output is de-energized. Any application of the trigger during the time delay will reset the time delay (t) and the output remains energized.	
<b>SINGLE SHOT</b> One Shot Momentary Interval <b>D</b>	Upon application of control voltage, the time delay relay is ready to accept a trigger. When the trigger is applied, the output is energized and the time delay (t) begins. During the time delay (t), the trigger is ignored. At the end of the time delay (t), the output is de-energized and the time delay relay is ready to accept another trigger.	

# DEFINITION OF TIMING FUNCTIONS

Function/Code	Operation	Timing Chart
<b>FLASHER (Off First)</b> <b>E</b>	<p>Upon application of control voltage , the time delay (t) begins. At the end of the time delay (t), the output is energized and remains in that condition for the time delay (t). At the end of the time delay (t), the output is de-energized and the sequence repeats until control voltage is removed.</p>	<p>The timing chart shows a constant high input voltage. The output consists of a series of pulses. Each pulse starts after a delay 't' from the beginning of the input voltage and has a duration of 't'. The sequence repeats until the input voltage is removed.</p>
<b>FLASHER (ON First)</b> <b>F</b>	<p>Upon application of control voltage , the output is energized and the time delay (t) begins. At the end of the time delay (t), the output is de-energized and remains in that condition for the time delay (t). At the end of the time delay (t), the output is energized and the sequence repeats until control voltage is removed.</p>	<p>The timing chart shows a constant high input voltage. The output starts with a pulse of duration 't' immediately after the input voltage is applied. This is followed by a delay 't', then another pulse of duration 't', and so on, repeating until the input voltage is removed.</p>
<b>ON/OFF DELAY</b> <b>G</b>	<p>Upon application of control voltage , the time delay relay is ready to accept a trigger. When the trigger is applied, the time delay (t1) begins. At the end of the time delay (t1), the output is energized. When the trigger is removed, the output contacts remain energized for the time delay (t2). At the end of the time delay (t2), the output is de-energized &amp; the time delay relay is ready to accept another trigger. If the trigger is removed during time delay period (t1), the output will remain de-energized and time delay (t1) will reset. If the trigger is reapplied during time delay period (t2), the output will remain energized and the time delay (t2) will reset.</p>	<p>The timing chart shows a constant high input voltage. Triggers are applied as pulses. The output is energized for a duration 't1' after each trigger pulse. If the trigger is removed during 't1', the output remains de-energized. If the trigger is reapplied during 't1', the output remains energized. After the trigger is removed, the output remains energized for a duration 't2' before de-energizing. A note states: '* For TD-7 catalog numbers, t1 &amp; t2 are the same length of time.'</p>
<b>SINGLE SHOT FALLING EDGE</b> <b>H</b>	<p>Upon application of control voltage , the time delay relay is ready to accept a trigger. When the trigger is applied, the output remains de-energized. Upon removal of the trigger, the output is energized and the time delay (t) begins. At the end of the time delay (t), the output is de-energized unless the trigger is removed and re-applied prior to time out (before time delay (t) elapses). Continuous cycling of the trigger at a rate faster than the time delay (t) will cause the output to remain energized indefinitely.</p>	<p>The timing chart shows a constant high input voltage. Triggers are applied as pulses. The output is de-energized until the trigger pulse ends. Immediately after the trigger pulse ends, the output is energized for a duration 't'. If the trigger is reapplied before the output de-energizes, the output remains energized. If the trigger is removed, the output de-energizes after delay 't'.</p>
<b>WATCHDOG Retriggerable Single Shot</b> <b>J</b>	<p>Upon application of control voltage , the time delay relay is ready to accept a trigger. When the trigger is applied, the output is energized and the time delay (t) begins. At the end of the time delay (t), the output is de-energized unless the trigger is removed and re-applied prior to time out (before time delay (t) elapses). Continuous cycling of the trigger at a rate faster than the time delay (t) will cause the output to remain energized indefinitely.</p>	<p>The timing chart shows a constant high input voltage. Triggers are applied as pulses. The output is energized for a duration 't' after each trigger pulse. If the trigger is reapplied before the output de-energizes, the output remains energized. If the trigger is removed, the output de-energizes after delay 't'.</p>
<b>TRIGGERED ON DELAY</b> <b>K</b>	<p>Upon application of control voltage , the time delay relay is ready to accept a trigger. When the trigger is applied, the time delay (t) begins. At the end of the time delay (t), the output is energized and remains in that condition as long as either the trigger is applied or the control voltage remains. If the trigger is removed during the time delay (t), the output remains de-energized &amp; the time delay (t) is reset.</p>	<p>The timing chart shows a constant high input voltage. Triggers are applied as pulses. The output is de-energized until the trigger pulse starts. At the end of the trigger pulse, the output is energized for a duration 't'. If the trigger is removed during this 't' period, the output remains energized. If the trigger is reapplied, the output remains energized. If the trigger is removed after the 't' period, the output de-energizes.</p>

# DEFINITION OF TIMING FUNCTIONS

Function/Code	Operation	Timing Chart
<b>REPEAT CYCLE (OFF 1st)</b> <b>L</b>	Upon application of control voltage , the time delay (t1) begins. At the end of the time delay (t1), the output is energized and remains in that condition for the time delay (t2). At the end of this time delay, the output is de-energized and the sequence repeats until control voltage is removed.	
<b>REPEAT CYCLE (ON 1st)</b> <b>M</b>	Upon application of control voltage , the output is energized and the time delay (t1) begins. At the end of the time delay (t1), the output is de-energized and remains in that condition for the time delay (t2). At the end of this time delay, the output is energized and the sequence repeats until control voltage is removed.	
<b>DELAYED INTERVAL Single Cycle</b> <b>N</b>	Upon application of control voltage , the time delay (t1) begins. At the end of the time delay (t1), the output is energized and remains in that condition for the time delay (t2). At the end of this time delay (t2), the output is de-energized. Control voltage must be removed to reset the time delay relay.	
<b>TRIGGERED DELAYED INTERVAL</b> <b>P</b>	Upon application of control voltage , the time delay relay is ready to accept a trigger. When the trigger is applied, the time delay (t1) begins. At the end of the time delay (t1), the output is energized and remains in that condition for the time delay (t2). At the end of the time delay (t2), the output is de-energized & the relay is ready to accept another trigger. During both time delay (t1) & time delay (t2), the trigger is ignored.	
<b>TRUE OFF DELAY</b> <b>R</b>	Upon application of control voltage , the output is energized. When the control voltage is removed, the time delay (t) begins. At the end of the time delay (t), the output is de-energized. Control voltage must be applied for a minimum of 0.1 seconds to assure proper operation. Any application of the control voltage during the time delay (t) will reset the time delay. No external trigger is required.	
<b>ON DELAY/ TRUE OFF DELAY</b> <b>S</b>	Upon application of control voltage , the time delay (t1) begins. At the end of the time delay (t1), the output is energized. When the control voltage is removed, the output remains energized for the time delay (t2). At the end of the time delay (t2), the output is de-energized. Control voltage must be applied for a minimum of 0.1 seconds to assure proper operation. Any application of the control voltage during the time delay (t2) will keep the output energized & reset the time delay (t2). No external trigger is required.	
<b>SINGLE SHOT-FLASHER</b> <b>T</b>	Upon application of control voltage , the time delay relay is ready to accept a trigger. When the trigger is applied, the time delay (t1) begins and the output is energized for the time delay (t2). At the end of this time delay (t2), the output is de-energized and remains in that condition for the time delay (t2). At the end of the time delay (t2), the output is energized and the sequence repeats until time delay (t1) is completed. During the time delay (t1), the trigger is ignored.	
<b>ON DELAY-FLASHER</b> <b>X</b>	Upon application of control voltage , the time delay begins (t1). At the end of the time delay (t1), the output is energized and remains in that condition for the time delay (t2). At the end of this time delay (t2), the output is de-energized and remains in that condition for the time delay (t2). At the end of the time delay (t2), the output is energized and the sequence repeats until control voltage is removed.	

# Your source for quality, innovative industrial control solutions

Macromatic Industrial Controls, Inc. designs and manufactures control, monitoring and protection products to manage your electrical processes and to protect your equipment from damaging fault conditions.

With a 45-year legacy of high-quality products and outstanding customer service, we continue to introduce innovative solutions that help our customers be more productive and efficient.

Our design and application experience makes it easy to find cost-effective advantages for your applications.

We continuously improve our products by integrating new technology and improving our manufacturing processes. The result is innovative reliable products, delivered on-time, every time.

**[www.macromatic.com](http://www.macromatic.com)**

**800.238.7474**



Better. By Design.

800.238.7474 | [www.macromatic.com](http://www.macromatic.com) | [SALES@MACROMATIC.COM](mailto:SALES@MACROMATIC.COM)

# Macromatic Industrial Controls Family of Products

MACROMATIC INDUSTRIAL CONTROLS

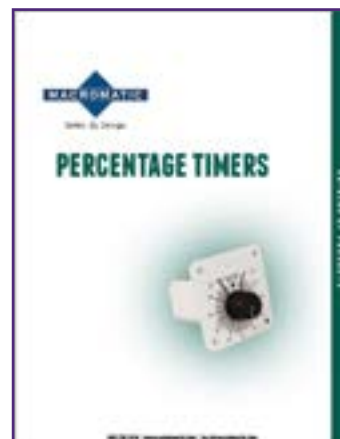
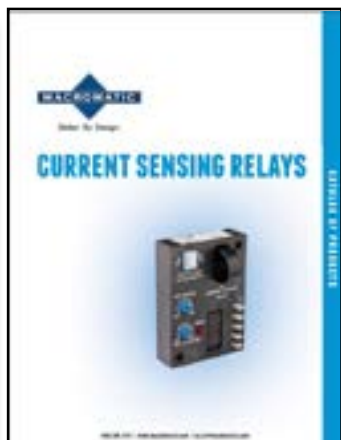

Better. By Design.



800.238.7474 | [www.macromatic.com](http://www.macromatic.com) | [sales@macromatic.com](mailto:sales@macromatic.com)

LCTTR00AEN0322